

New **MILLENNIUM**

Installation & Service Manual



5- Stage Reverse Osmosis Drinking Water System with Booster Pump



Made in USA



**Congratulations on choosing the Millennium®
5-Stage Reverse Osmosis (RO) Drinking Water System**

This high quality unit has been designed to fit under most kitchen and wet-bar sinks. We suggest that you carefully review the following information booklet before you attempt to install the reverse osmosis system.

Your Reverse Osmosis system is a highly sophisticated machine. We strongly recommend using only licensed & experienced technicians for installation and troubleshooting. To locate the closest authorised service technician contact your dealer or visit us at www.waterworldusa.com.

If you decide to install the unit yourself, please follow these installation instructions, which have been simplified with color coded tubing. All your local plumbing codes and regulations must be followed while installing your Millennium® RO system. For installation assistance, contact your local dealer.

Your local dealer

INSTALLATION DIAGRAM FOR MILLENNIUM® RO SYSTEM
(shown with standard faucet)

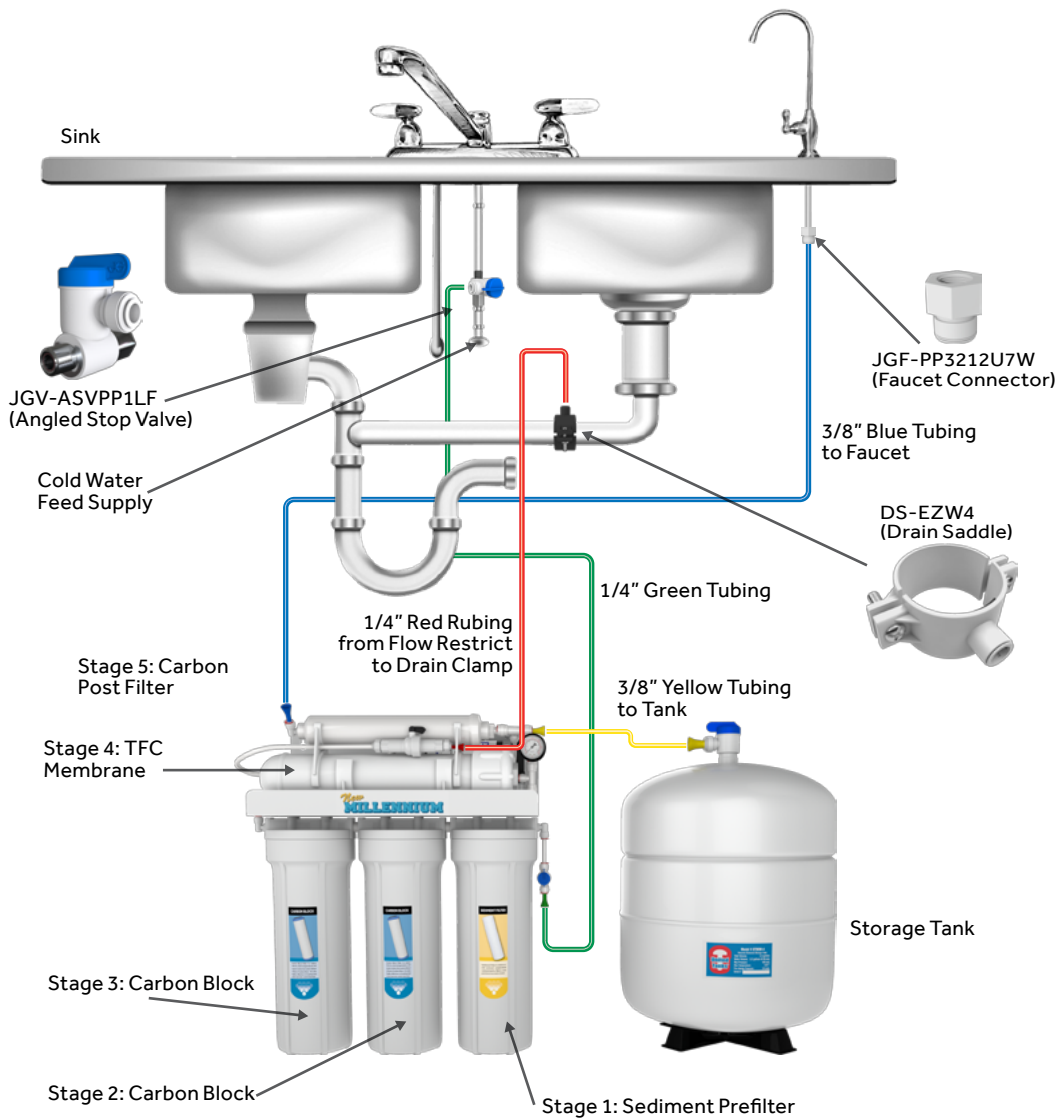

WARNING:

CONNECT YOUR SYSTEM TO THE COLD WATER SUPPLY ONLY. DO NOT USE A WATER SUPPLY THAT IS MICRO-BIOLOGICALLY UNSAFE, OR OF UNKNOWN SOURCE WITHOUT ADEQUATE DISINFECTION BEFORE OR AFTER THE MILLENNIUM® RO SYSTEM.

Color Coded Tubing-Standard Faucets	
Tubing	Directions
1/4" Green	Feed water supply line to inlet. Feed ball valve labeled "TO FEED"
3/8" Blue	Carbon post filter elbow labeled "TO FAUCET" to center threaded shank of faucet
3/8" Yellow	Carbon post filter tee labeled "TO TANK" to ball valve on storage tank
1/4" Red	Flow restrictor labeled "TO DRAIN" to DS-EZW4 drain clamp.

INSTALLATION DIAGRAM FOR MILLENNIUM® RO SYSTEM
(shown with optional air gap faucet)

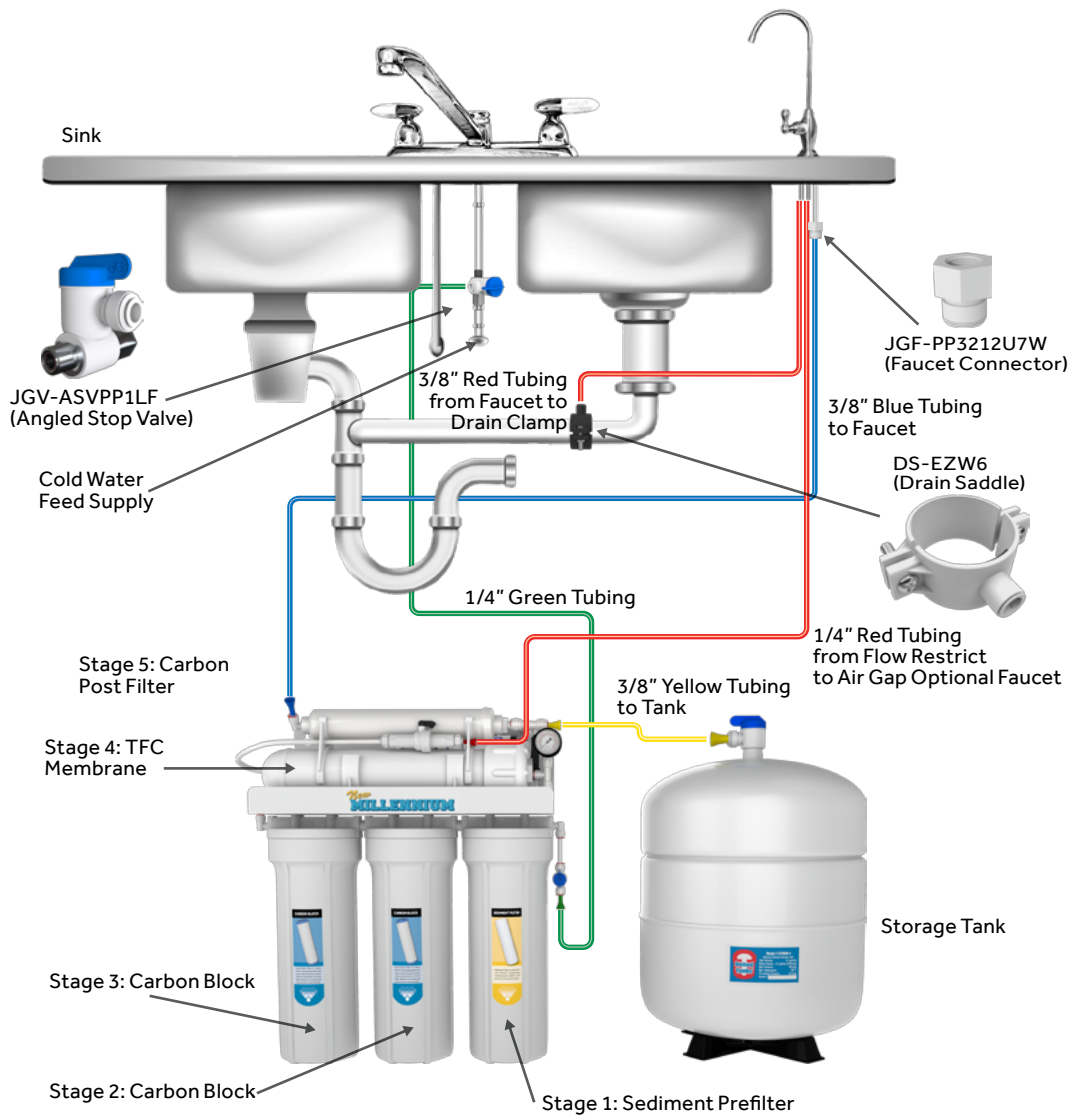









WARNING:

CONNECT YOUR SYSTEM TO THE COLD WATER SUPPLY ONLY. DO NOT USE A WATER SUPPLY THAT IS MICRO-BIOLOGICALLY UNSAFE, OR OF UNKNOWN SOURCE WITHOUT ADEQUATE DISINFECTION BEFORE OR AFTER THE SYSTEM.

Color Coded Tubing-Optional Air Gap Faucets	
Tubing	Directions
1/4" Green	Feed water supply line to inlet. Feed ball valve labeled "TO FEED"
3/8" Blue	Carbon post filter elbow labeled "TO FAUCET" to center threaded shank of faucet
3/8" Yellow	Carbon post filter tee labeled "TO TANK" to ball valve on storage tank
1/4" Red	Flow restrictor labeled "TO DRAIN" to air gap 1/4" drain/barb inlet at faucet air gap
3/8" Red	3/8" Barb on air gap to DS-EZW6 Drain clamp

Installation Kit

 <p>COLOR TUBING</p>	<p>1. Color Coded Tubing: (4 coils, 4 colors) ¼" Green Tubing (approximately 6 feet) ¼" Red Tubing (approximately 6 feet) ⅜" Yellow Tubing (approximately 6 feet) ⅜" Blue Tubing (approximately 6 feet) Optional 5th coil is added for air gap installations ⅜" Red Tubing (approximately 6 feet) Note: The color coded tubing matches the color coded plugs on the Millennium® RO system.</p>
 <p>JGV-ASVPP1LF</p>	<p>2. JGV-ASVPP1LF (Angled Stop Valve) is used for connecting into cold water supply in between the top of basin supply angle valve and the flex line that connects to the cold water sink faucet.</p>
 <p>DS-EZW4</p>	<p>4. DS-EZW4 (Drain Saddle) used for tapping into drain line when standard faucet is used. DS-EZW6 (Drain Saddle) used for tapping into drain line when air gap faucet is used.</p>
 <p>INS-TEFLON</p>	<p>5. Teflon Tape: Used on all threaded fittings to prevent water leakage. Eight rotations (layers) are adequate when using Teflon tape to secure any threaded fittings. The Millennium® RO already has Teflon tape on all of its fittings.</p>
 <p>JGV-PPSV501222W</p>	<p>6. JGV-PPSV501222W: (Storage Tank Ball Valve Quick Connect 3/8"). In normal operation, the Storage Tank Ball Valve must be in the "open" position. Add 8 layers of Teflon tape on top of the threaded tank outlet. Screw tank ball valve securely on threaded 1/4" NPT port. Connect yellow tubing from it to post filter tee.</p>
 <p>PNTK-150539</p>	<p>8. PNTK-150539: (White Wrench) Make sure the black rubber o-ring is properly in place in the filter housing after changing filters following any maintenance.</p>
 <p>EZM-LC -14 EZM-LC-38</p>	<p>10. EZM-LC-14: Locking clip for ¼" EZ Fitting, Red EZM-LC-38: Locking clip for ⅜" EZ Fitting, Red</p>
 <p>JGF-PP3212U7W</p>	<p>9. JGF-PP3212U7W: (Faucet Connector) to connect the faucet with blue 3/8" tubing coming from the post filter labeled to faucet.</p>

TAPPING INTO THE COLD WATER LINE

(Using the water supply adaptor Part # **JGV-ASVPP1LF**)

For flex metal or plastic line.

NOTE: The Millennium® RO system must be connected to the COLD water supply only.

- 1) Turn off the **cold** water supply to the sink faucet by locating the round or oblong handle and turning clockwise until the water supply is off.

NOTE: If the cold water shut off valve fails to turn off the water, the house supply can be turned off at the main water supply.

- 2) The water supply adapter may be installed at the faucet connection
- 3) Disconnect the 3/8" flex line from the base of cold water basin supply angle stop valve.
- 4) Re-connect the 3/8" **JGV-ASVPP1LF** Angle Stop Valve to the basin supply angle stop valve.

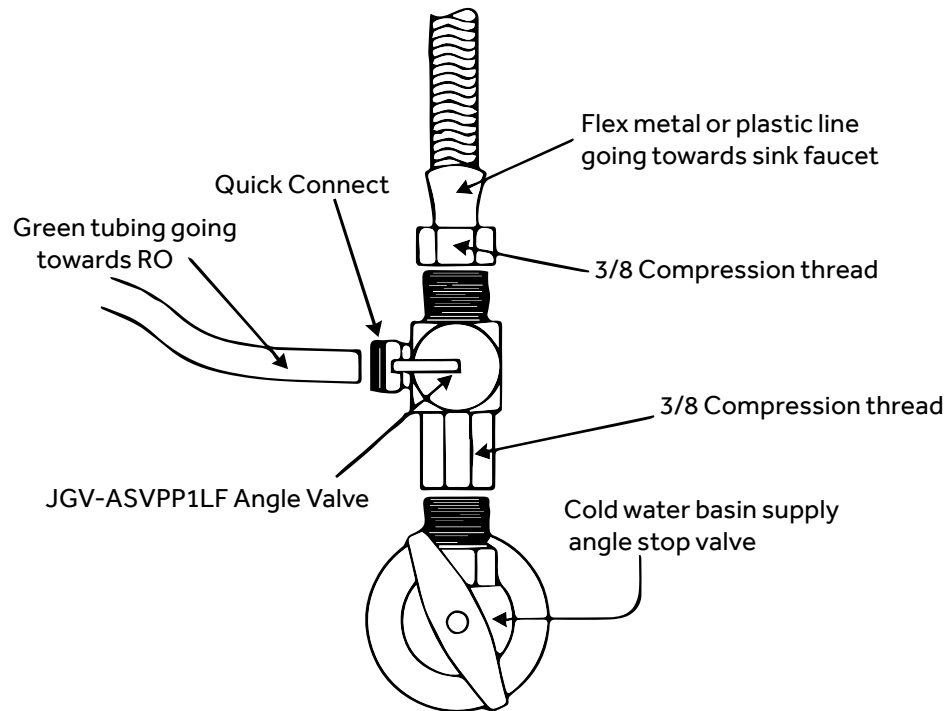

- 5) Re-connect flex line to the **JGV-ASVPP1LF** Angle Supply Valve.
- 6) Push green tubing in to Quick Connect fitting up to tube stop. Pull on the tubing to check it is secure. Test the system before use.

NOTE: All local plumbing codes must be followed to ensure proper installation and use of your system.

CAUTION: A pressure regulator is recommended for feedwater pressure above 80psi.

Tools Required:

- 1) **Hand drill for faucet hole. Use the appropriate bit for the surface you are drilling. (1/2" for non air gap faucets and - 7/8" drill bit for air gap ones).**
 - A) **Titanium bit for metal sinks.**
 - B) **Glass and tile bit or Relton cutter for porcelain sinks.**
 - C) **Diamond core bit for granite.**
- 2) **Phillips head screwdriver.**
- 3) **Adjustable crescent wrench.**
- 4) **Basin wrench.**
- 5) **1/4" drill bit for drain clamp.**

DRILLING THE HOLE FOR THE FAUCET

NOTE: SAFETY GLASSES SHOULD BE WORN TO PROTECT YOUR EYES WHILE DRILLING THE FAUCET WHOLE.

- 6) For best results, a 1/2" drill bit for a non air gap faucet or 7/8" dill bit for an air gap faucet should be used to drill a hole into your sink for the auxiliary faucet.
- 7) Carefully select the faucet location making sure it will have a neat water fall pattern and that the faucet stud will be accessible from below once the whole is completed.
- 8) **For Porcelain Sink:** Before starting the drill motor, apply firm downward pressure on the bit until a crunching occurs. This will help keep the drill from moving when starting the hole. Use a special porcelain hole cutter.
- 9) **For Stainless Steel Sink:** Before using the selected bit, an indent should be made with a center punch to keep the drill bit from moving. A small pilot hole will also aid the drill process.
- 10) For best results, keep steady firm pressure while drilling the hole. Too little pressure during the start will cause excess wear on the bit and progress will be slow.
- 11) Once the hole is complete, clean the area of metal chips and roughness around the hole. Metal chips will stain porcelain.

Warning: It is highly recommended for granite slate countertops, to use the assistance of a licensed professional to drill the hole for the faucet. Serious damage can occur to the counter if done by an inexperienced person.

MOUNTING THE FAUCET

Standard Faucet

- 1) Drill a 1/2" hole in the sink or the counter top, or use an existing hole.
- 2) Slide chrome cover plate and rubber gasket on to stem of faucet and place faucet onto sink, with the stem going through the hole.
- 3) Place metal slotted washer over threaded stem of faucet.
- 4) Tighten nut from under the counter surface to lock the faucet into place.
- 5) Thread the faucet connector onto threaded stem of faucet. Do not use Teflon tape.
- 6) Connect blue 3/8" tubing to faucet connector.

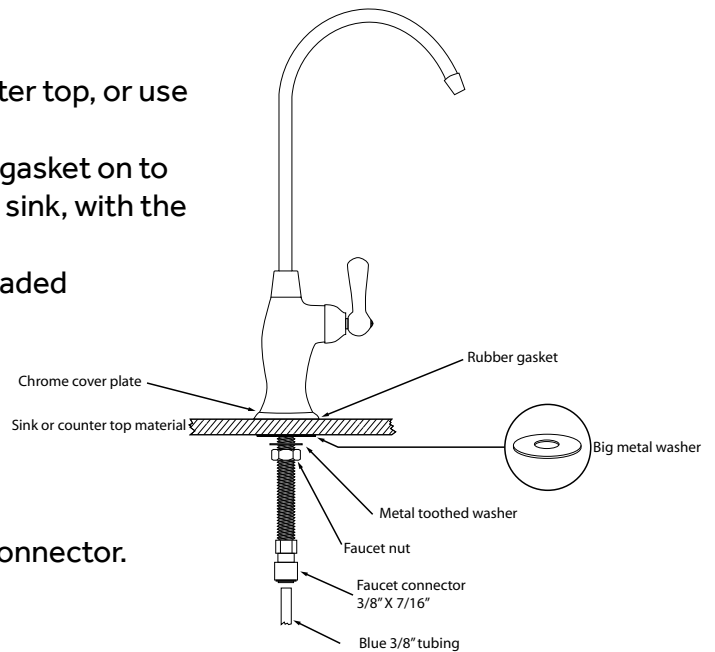

MOUNTING THE FAUCET

Air Gap Faucet (Optional)

- 1) Drill a 7/8" hole in the sink or the counter top, or use an existing hole.
- 2) Slide chrome cover plate and rubber gasket on to stem of faucet and place faucet onto sink, with the stem going through the hole.
- 3) Place metal slotted washer over threaded stem of faucet.
- 4) Place plastic spacer over threaded stem of faucet locking in place, slotted washer onto countertop.
- 5) Tighten nut from under the counter surface to lock the faucet into place.
- 6) Attach red 1/4" drain water discharge line to DRAIN INPUT barb. And red 3/8" drain line to DRAIN OUTPUT barb as shown.
- 7) Thread the faucet connector onto threaded stem of faucet. Do not use Teflon tape.
- 8) Connect blue 3/8" tubing to faucet connector.

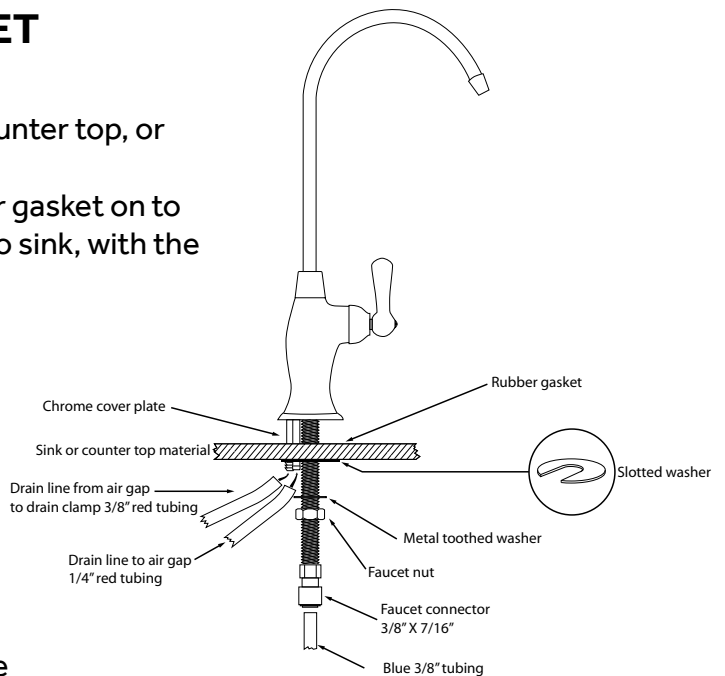

COMPRESSION CONNECTIONS

A compression fitting may be found with the faucet. To make the connections, slide a compression nut onto the tubing. Slip the white plastic sleeve onto the tubing with the beveled end towards the end of the tubing. Insert a brass or plastic insert into the tubing, bottom the tubing into the fitting, slide the nut up and tighten with a wrench. **DO NOT OVER TIGHTEN.** Do not use the brass sleeves on plastic tubing, use only plastic sleeves on plastic tubing.

* See page 2 for connection diagram on color coded tubing on systems with STANDARD FAUCETS.

* See page 3 for connection diagram on color coded tubing on systems with AIR GAP FAUCETS.

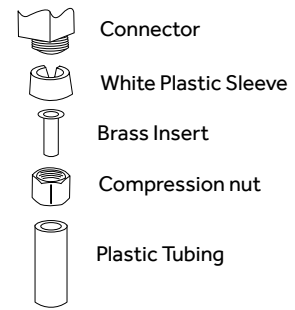

DRAIN CLAMP INSTALLATION

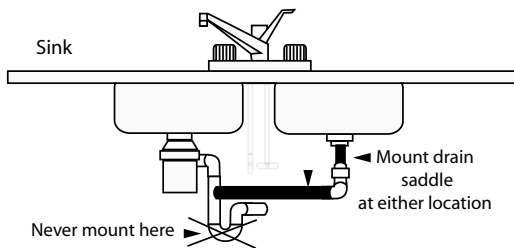

- 1) The drain clamp assembly should be installed above the trap and on the vertical or horizontal tail piece

- 2) Mark the hole position on the pipe and drill a 1/4" hole through one side of the pipe. Be careful **not** to drill the hole through both sides of the pipe.

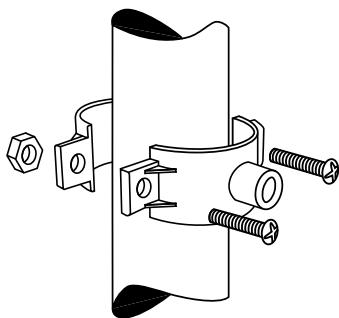
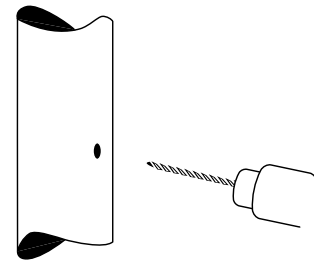

- 3) Affix gasket provided with the drain clamp onto inside of clamp piece matching the holes. The center hole on the gasket must be removed.
- 4) Make sure to align drain saddle to drilled hole. Attach drain clamp to drain pipe and tighten the two screws evenly.
- 5) Connect the 1/4" red tubing to the drain clamp (or 3/8" when air gap faucet is used).

POSITIONING THE SYSTEM

- 1) The head assembly will stand up in the sink cabinet or can be hung on screws.
- 2) The storage tank may be laid on its side. The bladder tank will function in both a horizontal or vertical position.
- 3) The head assembly and/or storage tank may be placed up to 10 feet from the point of use with some pressure loss.

EZ FITTINGS- QUICK CONNECT

Your Millennium® RO system is equipped with EZ fittings. The quick connect fittings feature leak proof installations. EZ Fittings provide efficient quick connection and disconnection resulting in reduction of service time and labor cost.

1 Cut tubing square

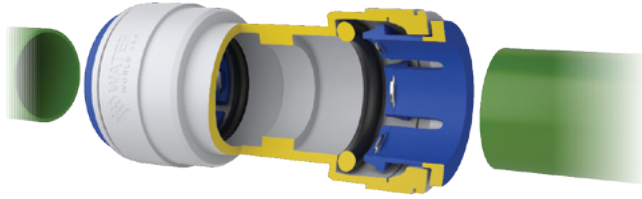

Cut the tube square. It is essential that the outside diameter be free of score marks and that burrs and sharp edges be removed before inserting into fittings. For soft thin walled plastic tubing, we recommend the use of a tube insert.

2 Insert tube

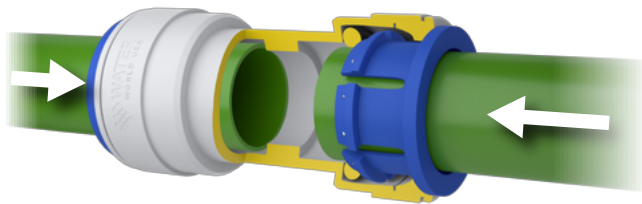

Fitting grips before it seals. Ensure tube is pushed into the tube stop.

3 Push up to tube stop

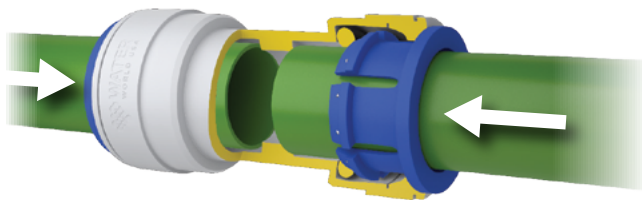

Push the tube into the tube stop. The collet (gripper) has stainless steel teeth which hold the tube firmly in position while the o-ring provides a permanent leak proof seal.

4 Pull to check secure

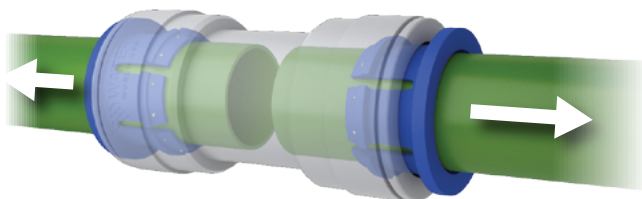

Pull on the tube to check that it is secure. It is a good practice to test the system prior to leaving site and/or before use.

Push in collet and remove tube

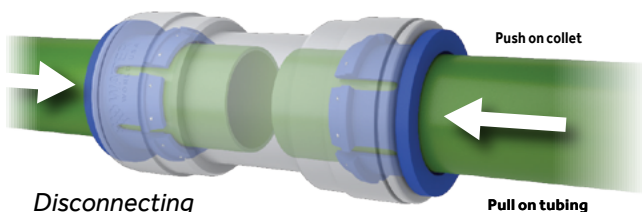

To disconnect, ensure the system is depressurized before removing the tube. Push in collet squarely against face of fitting. With the collet held in the position, the tube can be removed. The fitting can there be re-used.

START UP PROCEDURE

- 1) Check to see all connections are made
- 2) Check that the pre-filter and pre-carbon sumps are secure with o-rings in place using the housing wrench provided.
- 3) Slowly turn on the water by turning the needle valve counterclockwise or ball valve 1/4 turn, where handle is parallel to the tubing line.
- 4) The valve handle on top of the tank should be in the open position, parallel to the valve body.
- 5) The handle of the faucet should be in the closed position.
- 6) Check for leaks.
- 7) The Millennium® drinking water system makes 2 gallons of drinking water per hour and requires 2 hours before water is readily available.
- 8) During this initial fill period, you will hear water being discharged through the red drain line. This is normal as the contaminated water is being rejected by the reverse osmosis membrane.

The Millennium® RO system comes with a manual flushing valve on the drain line. This must be closed during normal operation.

WARNING: DO NOT DRINK WATER FROM THE FIRST TANK PRODUCED BY THE SYSTEM. COMPLETELY DRAIN IT FROM THE STORAGE TANK BY OPENING THE FAUCET. DISCHARGING MIGHT TAKE UP TO 15 MIN.

If you have any difficulties with the installation, or require additional information on your Millennium® RO system please consult your local dealer.

We thank you for purchasing our Millennium® reverse osmosis drinking water system. In order to maintain high quality pure water, it is important that scheduled maintenance be followed.

NOTE: MINIMUM PRESSURE REQUIRED TO OPERATE YOUR MILLENNIUM® SYSTEM IS 40 PSI. A BOOSTER PUMP ASSEMBLY IS REQUIRED WHEN FEED PRESSURE DROPS BELOW 40 PSI.

IMPORTANT NOTES-MUST READ:

- 1) All Millennium® RO system has been thoroughly tested at our factory. The system may have some residual water in it.**
- 2) Do not use this system on feed water that has biological contamination or if feed water is of unknown source.**
- 3) All local plumbing codes must be followed to ensure proper installation and use of your Millennium® RO System.**
- 4) Flush your Millennium® RO system (using manual flushing valve located on the unit assembly) frequently. Flushing the system for 5 minutes at a time will enhance the quality and prolong the life of the TFC membrane.**
- 5) Should you require additional information or need further technical assistance on Millennium® RO system, contact your local dealer.**

RECOMMENDED MAINTENANCE

CHANGING THE FILTERS

CAUTION: ANY REPLACEMENT FILTERS OR MEMBRANES NOT RECOMMENDED BY THE FACTORY CAN CAUSE SEVERE DAMAGE TO THE SYSTEM AND VOID ALL WARRANTIES.

Before starting maintenance, check the reverse osmosis system for TDS reduction to determine if membranes will or will not need to be changed.

If TDS reduction is less than 90% concentration, then the membrane should be replaced.

- 1) Shut off the water supply to the system.
- 2) Close storage tank ball valve.
- 3) Open the dispensing faucet to depressurize the system. (Allow 2 to 3 minutes).
- 4) Remove the filter housings by turning counter-clockwise.
- 5) Remove old filters and clean housings with a mild soap and water solution.
- 6) Check o-rings for deterioration and lubricate with an approved FDA silicone lubricant for o-rings or replace if needed.
- 7) Insert the appropriate new filters inside housings and replace them by mounting them in to position. Make hand tight plus $\frac{1}{8}$ to $\frac{1}{4}$ turn with housing wrench. DO NOT OVER-TIGHTEN. Over-tightening will cause cracks and leaks if not careful.

CAUTION: ALWAYS MAKE SURE THAT O-RINGS ARE SEATED PROPERLY INSIDE SUMPS BEFORE TIGHTENING CANISTERS.

- 8) If a membrane needs changing, remove the inlet tubing to the housing, unscrew the cap, and pull the membrane out using a needle nosed pliers. Clean the inside of the membrane housing with a mild soap and water solution.
- 9) Lubricate the o-rings on the membrane permeate tube with an approved FDA silicone lubricant. Insert into the housing with brine seal towards the opening. Make sure membrane is fully inserted and seated into place.
- 10) Reseal the membrane housing with the cap and reconnect tubing.
- 11) To replace the carbon in-line post filter, remove the tubing and fittings at either end. Clean the old Teflon tape off the threads and apply new tape. Screw the fittings into the new cartridge paying close attention to the flow direction. Reinsert tubing.

NOTE: ALWAYS MAKE SURE THAT O-RINGS ARE SEATED PROPERLY INSIDE SUMPS BEFORE TIGHTENING CANISTERS.

Replacement Components*:						
Model	1st Stage	2nd Stage	3rd Stage	4th Stage	5th Stage	Head Assembly
Millennium	PT-10-05	CTX-10-05	CTX-10-05	PTRO-1812-75	OMNP-K2540-BB	SYS-MILL110-HA

*Subject to change without notice

Stage 1) Sediment filter: This Pre-filter protects the system by reducing sediment from the water supply before entering the Carbon Blocks and TFC membrane. The snow-white Sediment Filter should be changed when the outside discolors but before the inner core discolors. The life of the Sediment Filter depends upon the condition of the water supply and amount of water usage. Once you Millennium® RO system is installed, check the Sediment Filter at 3 month intervals until a filter life is established and then changed accordingly. The average life of a Sediment filter is 6 months.

Stage 2 - 3) Carbon Blocks: These Pre-filters protects the system by reducing chlorine, organic and inorganic substance from the water supply before entering the TFC membrane. The average life of a Carbon Block is 12 months.

Stage 4) TFC Membrane: The high quality Thin Film Composite Membrane uses a separation process that removes ions, molecules and large particles from the water supply leaving high quality product water for consumption. This TFC Membrane should be changed when the product water has contamination levels, usually measured in TDS (Total Dissolved Solids) higher level than desired. The average life of a TFC Membrane is 24 to 36 months. Although TFC membranes are designed for non chlorinated feed supply, your Millennium® RO system is equipped with double carbon pre-filtration for chlorine reduction prior to the TFC membrane.

Stage 5) Carbon filter: This Post filter is designed to “polish” the product water by removing any remaining taste and odor creating outstanding drinking water. This filter should be changed at least every 12 months or if you experience an unusual taste or odor. The average life of a Post-Carbon is 12 months.

Head Assembly (sumps, housings, fittings, valves, and pump assembly) to be replaced every 7 years to ensure optimum operating conditions and prevent consequential damage.

Drain your storage tank frequently to ensure the freshness of the water in the storage tank by lifting the faucet handle into the open position until water flow stops from the tank. Return the faucet handle to the closed position and the tank will refill in 2 hours.

Bladder Tank Pressure 7 to 8 psi without any water in the tank. To recalibrate all water must be drained from the tank.

HOW TO MANUALLY FLUSH THE MEMBRANE

Manual Flushing: Flushing your system routinely (for 5 minutes each time) will enhance the performance and prolong the life of the TFC membrane.

The Manual Flushing Device is located in between the Membrane Housing and the Post Carbon on top of the Proline® RO system.

Flushing Instructions:

- 1) Close tank valve
- 2) Open faucet handle
- 3) Rotate flushing ball valve to FLUSH position for 5 minutes
- 4) Open tank ball valve and close faucet handle
- 5) Return flush ball valve to IN SERVICE position (closed)



Service Position. This is the normal operation position. With the closed valve.

Flush Position. The flush position is with an open valve.



TROUBLESHOOTING

SYMPTOM	CAUSE	CORRECTION	NOTES:
UNIT FAILS TO PRODUCE WATER	1) WATER SUPPLY IS TURNED OFF.	1) TURN WATER SUPPLY ON. 2) CHECK TO MAKE SURE FEED VALVE IS NOT CLOGGED.	
	2) NOT ENOUGH WATER PRESSURE TO SYSTEM.	1) CHECK FEED WATER PRESSURE. MUST BE AT LEAST 10PSI.	
	3) PREFILTERS CLOGGED.	1) CHANGE PREFILTERS.	
	4) FLUSH VALVE ON UNIT IS IN THE OPEN POSITION.	1) CLOSE THE FLUSH VALVE.	
	5) PUMP NOT WORKING	1) MAKE SURE TRANSFORMER IS PLUGGED TO ELECTRICAL OUTLET 2) REPLACE TRANSFORMER IF BURNED 3) REPLACE HI AND/OR LOW PRESSURE SWITCHES	
	6) SOLENOID VALVE NOT WORKING	1) REPLACE SOLENOID VALVE	
MILKY COLORED WATER	1) AIR IN SYSTEM	1) AIR IN SYSTEM IS A NORMAL OCCURRENCE WITH INITIAL STARTUP OF THE RO SYSTEM. THIS MILKY LOOK DISAPPEARS DURING NORMAL USE WITHIN 1 TO 2 WEEKS.	
NOISE FROM FAUCET	1) AIR GAP FAUCET	1) NORMAL WITH AIR GAP FAUCET	
	2) LOCATION OF DRAIN SADDLE	1) RELOCATE THE DRAIN TO HORIZONTAL	
	3) RESTRICTION IN DRAIN LINE	1) BLOCKAGE SOMETIMES CAUSED BY DEBRIS FROM GARBAGE DISPOSAL OR DISHWASHER	
UNIT PRODUCES WATER BUT ONLY GETTING A SMALL AMOUNT OUT OF TANK.	1) TANK BALL VALVE IS IN THE CLOSED POSITION.	1) OPEN THE TANK BALL VALVE.	
	2) PREFILTERS ARE CLOGGED.	1) CHANGE PREFILTERS.	
	3) MEMBRANE IS FOULED.	1) CHANGE MEMBRANE. 2) FIND REASON FOR FOULING. TO PREVENT FUTURE OCCURRENCE.	
	4) NO AIR PRESSURE IN TANK.	1) CHECK AIR PRESSURE IN TANK. MUST BE 8-10 PSI WHEN COMPLETELY EMPTY OF WATER. 2) BLADDER IN TANK IS RUPTURED. TANK MUST BE REPLACED WITH NEW ONE.	
	5) CHECK VALVE ON PRODUCT SIDE NOT HOLDING.	1) REPLACE CHECK VALVE ON UNIT.	
SLOW PRODUCTION	1) LOW WATER PRESSURE	1) MAKE SURE PUMP IS WORKING	
	2) CRIMPS IN TUBING	1) MAKE SURE TUBING IS STRAIGHT	
	3) CLOGGED PRE-FILTERS	1) REPLACE PRE-FILTERS	
	4) FOULED MEMBRANE	1) REPLACE MEMBRANE	
WATER TASTE OR SMELL OFFENSIVE	1) POST CARBON IS DEPLETED	1) REPLACE POST CARBON	
	2) FOULED MEMBRANE	1) CHANGE MEMBRANE. 2) FIND REASON FOR FOULING. TO PREVENT FUTURE OCCURRENCE.	
	3) SANITIZER NOT FLUSHED OUT	1) DRAIN STORAGE TANK AND REFILL OVERNIGHT	
NO DRAIN WATER	1) CLOGGED FLOW RESTRICTOR	1) REPLACE FLOW RESTRICTOR	
UNIT PRODUCING WATER TOO RAPIDLY	1) TUBING CONNECTED INCORRECTLY	1) MAKE SURE DRAIN AND PRODUCT LINES ARE CONNECTED PROPERLY.	
	2) MEMBRANE FAILURE	1) CHLORINE MAY HAVE PASSED THROUGH TO MEMBRANE. REPLACE MEMBRANE AND CHANGE PREFILTERS. 2) MEMBRANE MISHANDLED OR STORED IMPROPERLY. REPLACE MEMBRANE.	
WATER RUNS TO DRAIN ALL THE TIME	1) AUTO SHUTOFF NOT CLOSING.	1) REPLACE AUTO SHUTOFF.	
	2) CHECK VALVE ON PRODUCT SIDE NOT HOLDING	1) REPLACE CHECK VALVE.	
LEAKS	1) FITTINGS ARE NOT TIGHTENED	1) TIGHTEN FITTINGS AS NECESSARY	
	2) MISSING O-RINGS	1) CONTACT LOCAL DEALER	
	3) MISALIGNMENT OF HOLE IN DRAIN SADDLE	1) REALIGN DRAIN SADDLE	

Your Reverse Osmosis system is a highly sophisticated machine. We strongly recommend using only licensed & experienced technicians for installation and troubleshooting. To locate the closest authorized service technician contact your dealer or visit us at www.waterworldusa.com.

MILLENNIUM® LIMITED WARRANTY

Congratulations on the purchase of your WW-USA Water System. WW-USA warrants that the Products identified below are free from material defects in materials and workmanship. Any defective part will be replaced at no charge for the part if any failure caused by the defect occurs within the following time periods originating from the date of original system installation. This Limited Warranty does NOT include freight or labor charges. To place your system under this Limited Warranty, you or your authorized WW-USA dealer must register your equipment with WW-USA within 30 days of the installation date. For service under this Limited Warranty, contact your authorized WW-USA dealer. Retain your receipt along with this Limited Warranty for reference if service is necessary.

The Millennium® reverse osmosis system is warranted to be free from defects in materials and workmanship under normal use within the operating parameters listed below. For a period of one year from the date of purchase Millennium® will repair or replace any part of the reverse osmosis system with the exception of the filters and electrical components if any.

CONDITIONS OF WARRANTY:

Millennium® assumes no responsibility for incidental or consequential damages; for damages arising out of misuse of the product or the use of any unauthorized attachment; for damages resulting from improper installation or for damages resulting from the use of the product with a defective plumbing system.

In no event shall Millennium® be liable for any direct, indirect, special, punitive, incidental, exemplary or consequential damages, attorney’s fees or any damages whatsoever, even if Millennium® has been previously advised of the possibility of such damages, whether in an action under contract, negligence, or any other theory, arising out of or in connection with the use, inability to use, or performance of the Millennium® system.

Millennium® is not responsible or liable for damage to any part of the Millennium® system because of misuse; misapplication; negligence; alteration; accident; installation; neglect; misapplication; physical damage; fouling and/or scaling of the membrane by minerals; sediment; bacterial attack; or operation contrary to our instructions, incompatibility with accessories not authorized for use with the system, or damage caused by freezing, flood, fire, or Act of God.

In no event shall Millennium® its subsidiaries or affiliates, or their respective officers, directors, employees, representatives, dealers or agents be liable for special, incidental, consequential, punitive, indirect, or other special damages, including but not limited to, loss of data, use, or profits, however caused, whether for breach of contract, negligence or otherwise, and whether or not Millennium® has been advised of the possibility of any such damages.

Millennium® assumes no warranty liability in connection with this reverse osmosis system other than that specified herein. This warranty is in lieu of all other warranties, expressed or implied, including warranties of fitness for a particular purpose.

WARRANTY SERVICE:

Millennium® will provide warranty service under the following conditions:

- 1) **Contact your local dealer who will obtain return authorization instructions.**
- 2) **Ship the unit or part freight prepaid for warranty evaluation or service with RMA # written on package. Systems or parts covered under the warranty shall be repaired (or, at our option replaced) and returned without charge.**

CONDITIONS FOR OPERATION:

Operating Parameters:	
System Pressure	40-80psi*
Temperature	4-38 C (39-100 F)
pH Range	3.0 to 11.0
Maximum feed TDS level	2000 ppm
Maximum Turbidity	1.0 Net Turbidity (NTU)
Chemical Parameters:	
Maximum Hardness	350mg/L (20 gpg)
Maximum Iron (Fe)	0.1 mg/L
Maximum Manganese (Mn)	0.05 mg/L
Maximum Hydrogen Sulfide (H2S)	0.00 mg/L
Maximum Chlorine (Cl2)	2.00 mg/L

*A pressure regulator is recommended for feedwater pressure above 80 psi.

New
MILLENNIUM



Made in USA