

INTELLICLEAR® RO600

600 GPD Under-sink Tankless Reverse Osmosis
Water Purifier with Faucet.

USER MANUAL

Rated voltage: 100-125V AC
Rated frequency: 50/60Hz



★★★★★
Please register your
new system for
warranty support
and discounted filter
replacement cartridges.

★★★★★

About this User Manual

This manual serves the following purpose:

- To familiarize the operator with the equipment.
- To explain the installation and setup procedures.
- To give specifications and troubleshooting information.
- To provide basic programming information.
- To explain the various modes of operation.

Read this Manual Before Operating Your System

This high quality unit has been designed to fit under most kitchen and wet-bar sinks as well as feed multiple dispensers and ice machines. We suggest that you carefully review the following information booklet before you attempt to install the reverse osmosis system.

Your Reverse Osmosis system is a highly sophisticated machine. We strongly recommend using only licensed & experienced technicians for installation and troubleshooting. To locate the closest authorized service technician contact your dealer or visit us at www.waterworldusa.com.

If you decide to install the unit yourself, please follow these installation instructions, which have been simplified with color coded tubing. All your local plumbing codes and regulations must be followed while installing your IntelliClear® RO system. For installation assistance, contact your local dealer.

TABLE OF CONTENTS

	page
Safety instructions.....	1
Important Safeguards.....	5
Intended use	5
Product overview	6
Before first use	9
Preparation	9
Connection diagram	9
How to use the quick-connect fittings	10
Installation	11
Installing the 3-way valve	11
Installing the faucet	12
Installing the drain saddle	13
Connecting the PE-tubes to the main unit.....	14
Using the product	14
Maintenance (Filter replacement)	16
Troubleshooting	17
Cleaning	18
Specifications	18
Disposal.....	18
1 Year limited warranty.....	19



The packaging materials are recyclable, we recommend that you separate plastic, paper and cardboard and place into proper recycling containers.







SAFETY INSTRUCTIONS

Safety Instructions









All instructions described should be carefully read and followed.

- These instructions are precautions to prevent the risks of serious injury or death of the user, and any damages to property.

















MARKINGS	
 WARNING	Indicates a situation which, when not avoided, has the potential to result in death or severe injury;
 CAUTION	Indicates a situation which, when not avoided, results or has the potential to result in minor injury;
 DANGER	Indicates a situation which, when not avoided, results in death or severe injury.

SYMBOLS	
 PROHIBITED!	 PROHIBITED! Indicates prohibited actions. Detailed instructions would be indicated on the inside of the circle or around the symbol in figures or in writing.
 IMPORTANT	 IMPORTANT Indicates mandatory actions. Detailed instructions would be indicated on the inside of the circle or around the symbol in figures or in writing.
 CAUTION	 CAUTION Recommends to take precautions. Detailed instructions would be indicated on the inside of the triangle or around the symbol in figures or in writing.



* To use

 WARNING	
 Instruction	This product should be installed and maintained only by an experienced adult following Uniform Plumbing Code (UPC) or other applicable state or local codes. If in doubt, consult a professional. The electrical installation must comply with all applicable local or national codes: ANSI/NFPA70, National Electrical Code (NEC). This includes installation of a GFCI outlet that is required in all wet or damp locations.
 Keep away from flammable materials	Explosion Hazard Keep flammable materials and vapors, away from appliance. Use nonflammable cleaner. 
 Prohibit	Do not use an extension cord with the water purifier. 
 Electric shock	Do not use damaged power lines, power plug or loose power socket. 













SAFETY INSTRUCTIONS

 Instruction	Place the water purifier on a solid level surface.	
 Prohibit	Do not tilt or shake the system while is it connected to a water source, since it can cause the unite to leak.	
	At low temperature, it is necessary to drain water to avoid damage caused by ice.	
	Do not place the water purifier close to highly corrosive environment.	
 Prohibit	Do not immerse cord, plug, or any other part of the water purifier in water or other liquids.	
 Away from children	The product is not intended for use by children or individuals with physical, sensory, or mental limitations unless supervised. Young children should be supervised to ensure the proper use of the water purifier.	
	A 110-240V, 50/60 Hz, AC only, 15 A or 20 A fused, grounded electrical supply is required. It is recommended that a separate circuit serving only your water purifier be provided. Use an outlet that cannot be turned off by a switch. Do not use an extension cord.	
 No disassembly and repair without permission	Electrical Shock Hazard Plug into a grounded 3 prong outlet. Do not remove ground prong. Do not use an adapter. Do not use an extension cord. Failure to follow these instructions can result in death, or electrical shock.	
 Insert plug	Insert the power plug securely to the base. If the cord is incompletely inserted it may cause fire due to electric spark or heat generation.	
 Wipe off dust	Wipe off dust or dirt accumulated on the plug of power line. The accumulated dust or dirt may cause fire, electric shock, or short circuit.	
 No modification	Do not disassemble, remodel, modify and repair the water purifier. This may cause fire, electric shock or fault, and cause injuries. If repair is required, please contact with the vendor of the water purifier.	
	Do not place anything on the water purifier. It may cause fire, electric shock or injuries.	
 Care for cleaning	Do not use abrasive or harsh cleaners such as window sprays, scouring cleanser, flammable fluids, cleaning waxes, concentrated detergents, bleaches, or cleansers containing petroleum products on plastic parts. Do not use paper towels, scouring pads, or other harsh cleaning tools. These can scratch or damage the finish on your system.	











SAFETY INSTRUCTIONS

 No freeze	Do not freeze. It may cause leakage or other malfunctions. Reverse osmosis membrane filters will be damaged below 0°C.
	Do not use this product with micro-biologically unsafe water or water from unknown sources or quality. Do not connect the product to water inlets with water temperature below 40 °F (4 °C) or exceeding 100 °F (38 °C). The required working pressure of the product is 14-100 psi. If the water pressure is lower or higher than this, install a pressure boosting device or pressure reducing device accordingly. 

CAUTION







 Prohibit	Do not use outdoors. Keep the water purifier in a dry place and away from direct sunlight. 
 No pulling by force	Unplug the power cord by pulling straight out. Do not pull on the cord. 
 Application environment	For household use only. This appliance is intended to be used in a household and similar applications.
 Application range	The water purifier usage temperature range is between 40 F – 100 F. Lower temperatures will affect flow rate. The water purifier should also not be installed in a location susceptible to freezing.
 Away from fire	Do not place the water purifier close to fire. It may damage to the water purifier and cause fire. 
 Prohibit	Do not place anything on top of the water purifier. Do not lean, shake or push the water purifier.
 No water spraying	Do not install the water purifier close to where water may splash. It may cause electric shock or fire due to an insulation deterioration.
	Do not install water purifier or any parts of the water purifier close to a gas range or other combustion sources.
	Do not reset the filters prematurely. Filters must be replaced to avoid contamination of germs inside the water purifier.
	After installing, check all water connections for leaks.

SAFETY INSTRUCTIONS



	Do not connect hot water supply inlet to the water purifier, hot water will damage the RO membrane.	
	If water is leaking from the water purifier, immediately unplug the power cord and turn off the water valve.	
	Replace all the filters regularly. The filter life LED will flash when the filter need to be changed. Please see page 5 for “General Filter Replacement Intervals.”	
	Do not install close to strong magnetic fields.	
	Installation and removal of water purifier should be done by a plumbing professional.	
	It is normal that hear a slight noise and vibration when the water purifier is producing water. Normal sounds: vibration, water running to fill tank.	

* To inspection and maintenance

WARNING

 No disassembly and repair without permission	If the water purifier’s power cord is damaged, it must be replaced by the manufacturer, a service agent or similarly qualified persons.	
 Prohibit	Do not clean the water purifier with high water pressure equipment. It may cause electric shock or fire due to an insulation deterioration.	
 Disconnect power plug	Before cleaning the water purifier, disconnect the power cord from the outlet.	
 Instruction	Unplug the power cord immediately and call for service if you smell anything or hear any abnormal sounds coming from the water purifier.	

CAUTION

 Certified technician	Service should be performed only by a certified technician.	
 Indoor	Do not use outdoors. Keep the water purifier in a dry place and away from direct sunlight.	
	This system utilizes an internal water pressure pump. During a power outage, the system will not operate. If you are aware of a scheduled power outage, or bad weather event that might cut the power, we recommend storing water in advance.	

IMPORTANT SAFEGUARDS

⚠ WARNING

To ensure safety, avoid injuries or property loss, be sure to follow all safety recommendations. Ignoring them may result in damage to the product and void the warranty.



SAVE THESE INSTRUCTIONS

INTENDED USE

- The product is intended to filter and improve the quality of tap-water from the mains water supply.
- Do not use this product to filter well water or water from other sources other than from the mains water supply.
- The product is intended for domestic use only.
- The product is intended to be used in dry indoors areas only.
- No liability will be accepted for damages resulting from improper use or non-compliance with these instructions.

Advanced Multistage Dual Cell Filtration



General Filter replacement Intervals

- Filter - Replace every 12 months*
- *Filter life may vary depending upon water usage and source water quality

"Did You Know?"

Reverse Osmosis (RO) is a water treatment process that removes contaminants from water by using pressure to force water molecules through a membrane. During this process, the contaminants are filtered out and flushed away, providing clean and safe drinking water.

PRODUCT OVERVIEW

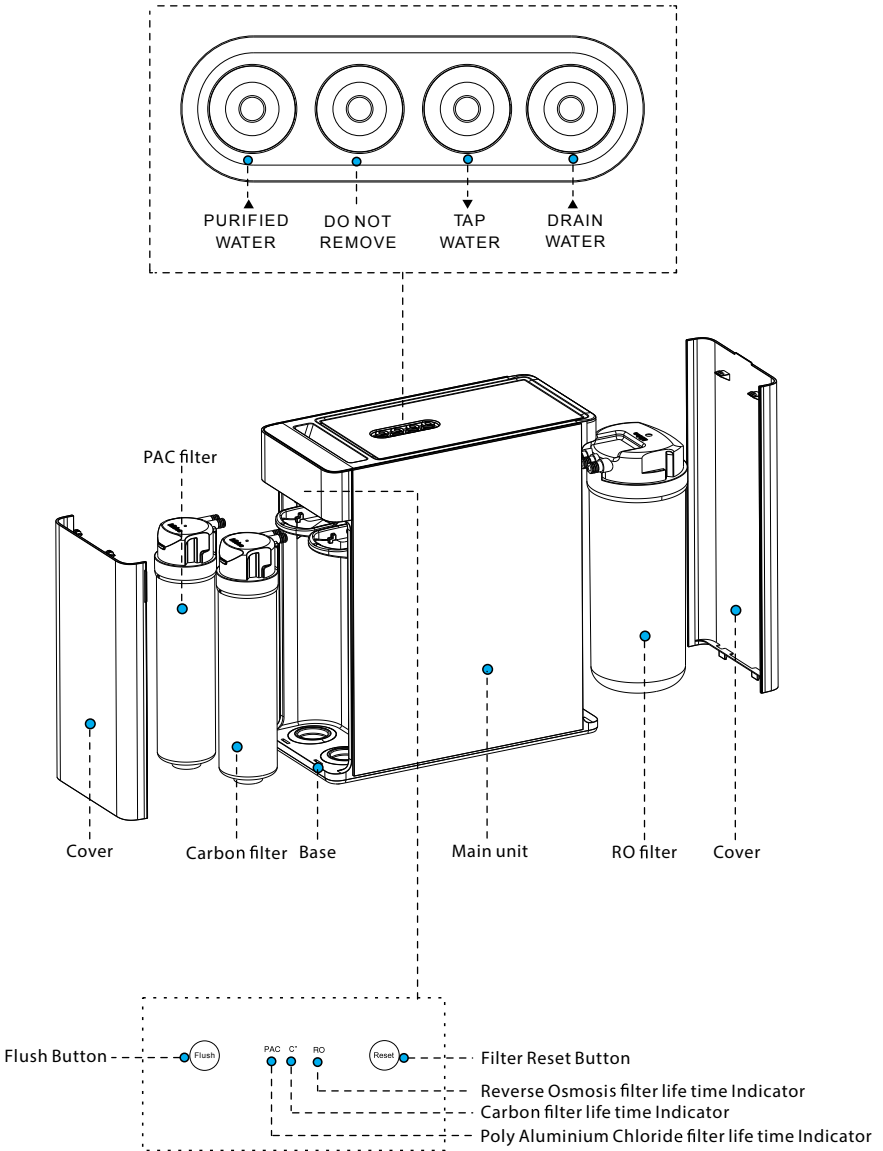

PRODUCT OVERVIEW

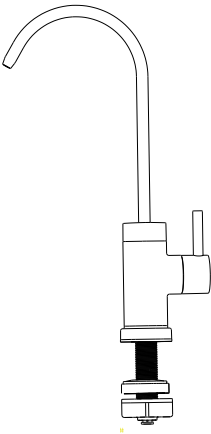

Faucet

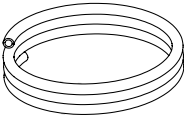

PE-tube (3x)
WHITE: TAP WATER

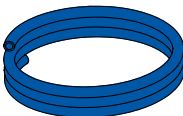

PE-tube (3x)
BLUE: PURIFIED WATER

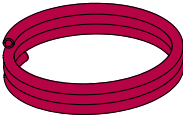

PE-tube (3x)
RED: DRAIN WATER



Drain saddle



Square gasket

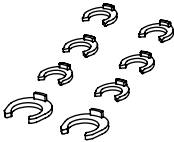

Locking clip (8x)

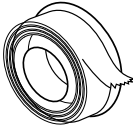

Thread seal tape

PRODUCT OVERVIEW

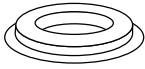

Large rubber gasket

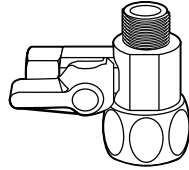

3-way valve

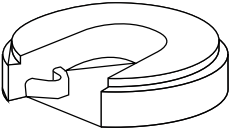

Plastic washer



Medium rubber gasket

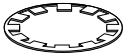

Tooth lock washer

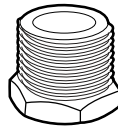

1/2" adapter

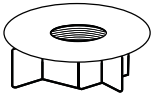

Locking nut



Small rubber gasket

Required tools (not included)

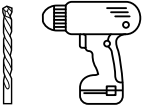

Power drill with 1/4" drill bit



Bucket

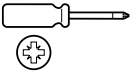

Cross-head screwdriver

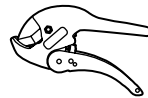

Pipe cutter



Adjustable wrench



Safety glasses

BEFORE FIRST USE

⚠ WARNING To avoid danger of suffocation, keep plastic bags away from children and pets. Do not use plastic bags in cribs, beds, carriages or playpens.

1. Remove all the packing materials.
2. Remove and review all components before use.
3. Check the product for transport damages.
4. Before connecting the product to the power supply, check that the power supply voltage and current rating corresponds with the power supply details provided on the product rating label.

PREPARATION

1. This product should be installed and maintained only by an experienced adult following Uniform Plumbing Code (UPC) or other applicable state or local codes. If in doubt, consult a professional.
2. Ensure the mains water supply meets the product requirements, see chapter **Specifications**.
3. It is recommended to place the main unit in the cabinet under a sink on a flat and level surface. Before starting the installation, place the product in its planned location to ensure the location is suitable.
4. Ensure there is sufficient access to the plumbing under the sink and the main water valves.
5. Ensure the supply cord and PE-tubes can be routed without kinking or bending.
6. Ensure all required tools are available before starting the installation.
7. Leave at least 4" (10 cm) of free space around the product to allow for proper ventilation.

NOTICE It is normal for the water purifier to emit some noise and slightly vibrate when in use, this is normal.

CONNECTION DIAGRAM

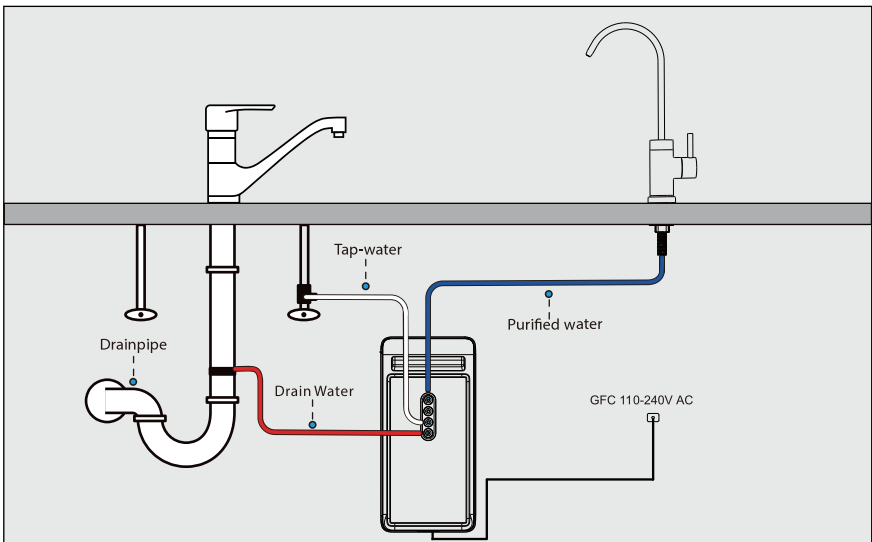

HOW TO USE THE QUICK-CONNECT FITTINGS

All parts of the product that connect with PE-tubes are equipped with quick-connect fittings.

To attach a PE-tube to a quick-connect fitting:

1. Push the PE-tube into the fitting. There is an existing mark at the end of the tube for you to confirm if the tube is fully inserted into the fitting.
2. Slide the Locking clip between the quick-connect release and the fitting (Fig.1).

To disconnect a PE-tube from a quick-connect fitting:

1. Remove the locking clip .
2. Push and hold the quick-connect release.
3. Pull the PE-tube out of the fitting (Fig.2).

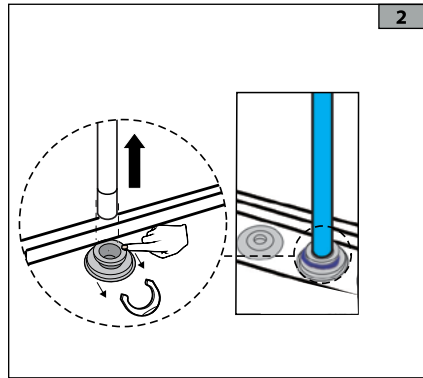
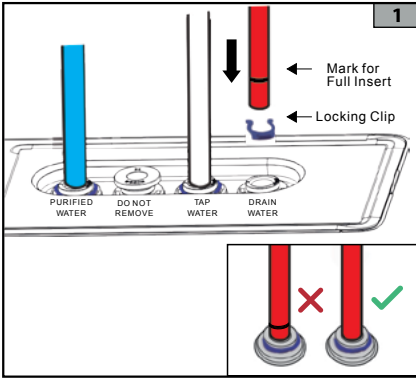

INSTALLATION STEPS

Step 1: Installing the 3-way valve

NOTICE The 3-way valve has a threaded diameter of 3/8" and can be converted to 1/2" using the provided 1/2" adapter.

1. Locate the cold water supply shut-off valve under the sink and close it.
2. Open the sink faucet to release remaining pressure in the cold-water line. Make sure the pressure has been released before proceeding to the next step. Have a bucket ready to capture any water left in the water line.
3. Use an adjustable wrench to unscrew the cold-water line from the water supply shut-off valve.
4. Wrap the threads of the 3-way valve with thread seal tape.
5. Remove any old thread seal tape from the water supply shut-off valve.

NOTICE The 1/2" adapter and small rubber gasket can be either placed on top of the 3-way valve (Fig.3-A) or on top of the water supply shut-off valve (Fig.3-B).

6. Place the medium rubber gasket on the water supply shut-off valve and screw the 3-way valve onto the water supply shut-off valve using an adjustable wrench. Make sure that the 3-way valve is connected securely. Do not over tighten the connections, this may damage the fittings (Fig. 3).
7. Connect one end of the tap-water PE-tube (WHITE) to the 3-way valve by pushing it into the quick-connect fitting. Secure the PE-tube with the safety clips. (see chapter **How to use the quick-connect fittings**) (Fig. 4).

NOTICE Do not connect the other end of the PE-tube to the main unit (4) at this time.

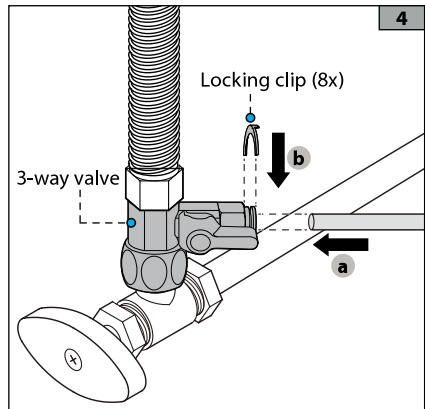
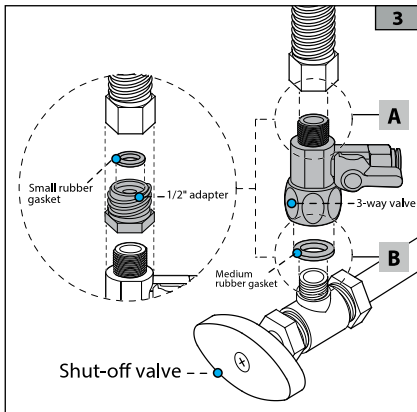

8. Wrap the thread seal tape in the direction of the thread counterclockwise.
9. When wrapping the thread seal tape, start from the 2nd tooth of the thread head with slight force and leave the 1st tooth unwound, wrap 8-10 turns.
10. After wrapping thread seal tape, once tightened, do not allow to withdraw the thread (screw back), otherwise you have to re-wrap it (Fig. 5).

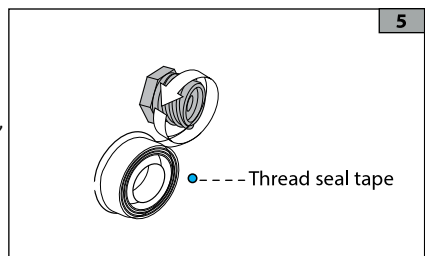

INSTALLATION

Step 2: Installing the faucet

⚠ CAUTION Risk of damage!

Some kitchen counter top materials, including granite, porcelain, steel and plastic resin, require specialized tools and can be irreparably damaged if unsuitable tools are used.

Installing the faucet requires a hole in the counter top or sink. The hole size must be 1" in diameter.

1. Use a pre-existing hole if available. If no pre-existing hole is available, consider hiring a professional.
2. Place the large rubber gasket over the hole and place the stem of the faucet through the hole (Fig.6).
3. First place the plastic washer and then the tooth lock washer onto the stem of the faucet and secure them using the locking nut on the threaded stem (Fig.7).

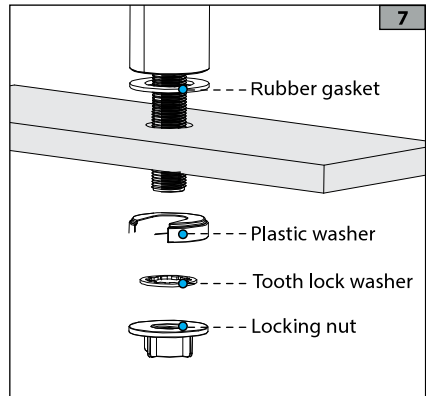
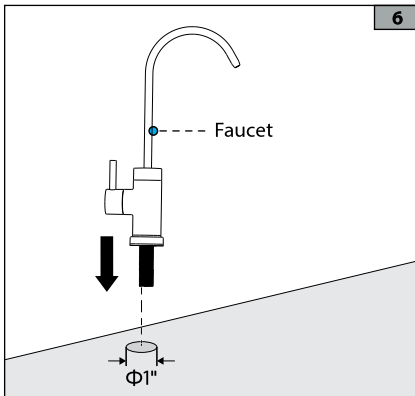

4. Connect one end of the Blue purified water PE-tube (BLUE) to the faucet by pushing it into the quick-connect fitting. Secure the PE-tube with the safety clips (see chapter **How to use the quick-connect fittings**).

NOTICE Do not connect the other end of the PE-tube to the main unit at this time.

INSTALLATION

Step 3: Installing the drain saddle

NOTICE The drain saddle fits around a standard 1-1/2" drainpipe.

1. Select and mark a location on the drainpipe (A or B). The location must be straight, at least 3" and before the P-trap (Fig. 6). It is recommended to use a vertical location (Fig. 10)
2. Place the drain saddle around the drainpipe to check the fit.

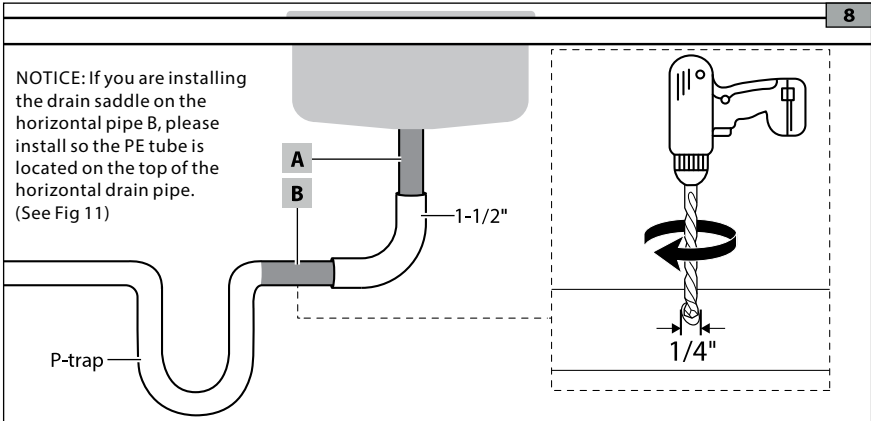

3. Drill a 1/4" hole. Make sure to only drill through one side of the drainpipe (Fig.8).
4. Remove any loose plastic from the drainpipe.
5. Push the wastewater PE-tube (RED) into the quick-connect fitting on the drain saddle (Fig.10). Insert the wastewater PE-tube at least 0.6" to avoid any leakage.
6. Remove the protective plastic from the square gasket.
7. Place the square gasket through the PE- tube and it to the inner wall of the drain saddle (Fig.9).
8. Connect the two halves of the drain saddle with the nuts and screws. while leaving the tubing in the hole. Tighten both sides equally to secure the drain saddle and remove the drill bit from the quick-connect fitting (Fig.11).
9. Secure the PE-tube with the safety clips (see chapter **How to use the quick-connect fittings**).

NOTICE: If you are installing the drain saddle on the horizontal pipe B, please install so the PE tube is located on the top of the horizontal drain pipe. (See Fig 11.)

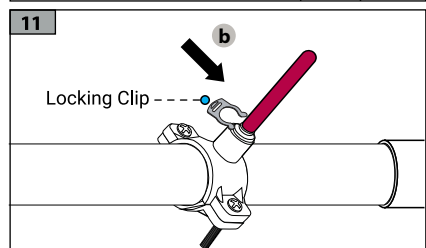
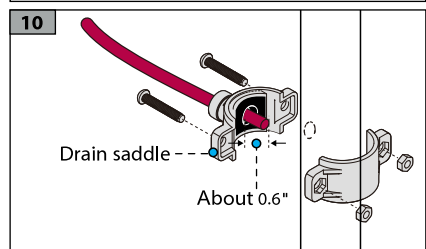
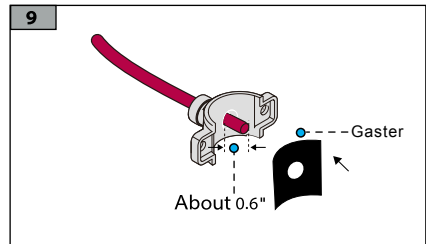

INSTALLATION

Step 4: Connecting the PE-tubes to the main unit

The main unit has one **Wastewater** outlet, **Purified water** outlet and **Tap-water** inlet. These correspond to the three PE-tubes.

1. Remove the protective silicon plugs from the inlet and outlets on the main unit (Fig.12-a)
2. Push the Red wastewater PE-tube into the quick-connect fitting of the **DRAIN WATER** outlet (Fig.12-b). The other end of the wastewater PE-tube is connected to the drain saddle.
3. Push the White tap-water PE-tube into the quick-connect fitting of the **Tap-water** inlet. The other end of the tap-water PE-tube is connected to the 3-way valve.
4. Push the Blue purified water PE-tube into the quick-connect fitting of the **Purified** outlet. The other end of the purified water PE-tube is connected to the faucet.
5. Secure each of the PE-tube with the safety clips (see chapter **How to use the quick-connect fittings**) (Fig. 9-c).

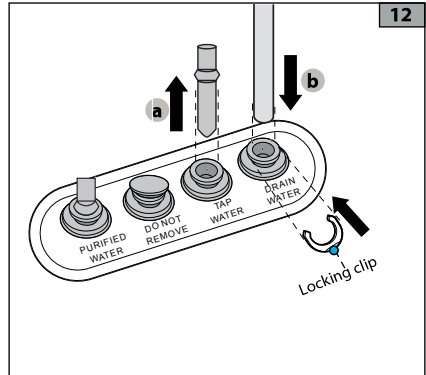

Step 5: Checking for leaks

CAUTION Risk of damage!

Do not connect the main unit to the power supply at this time. Always check for leaks before connecting the product to the power supply.

1. Close the faucet.
2. Open the 3-way valve and the water supply shut-off valve (Fig. 13).
3. Check all connection points for any leaks.
4. Use the water supply shut-off valve to turn off the water supply if any leaks are spotted.

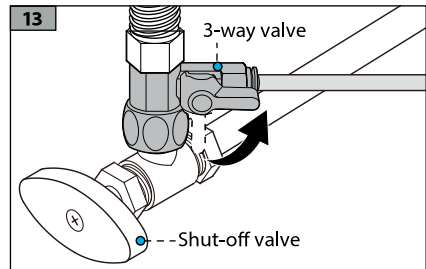

USING THE PRODUCT

CAUTION Risk of damage!

- Close the 3-way valve and disconnect the product in the event of a water shutdown or pipeline maintenance. Always flush the water lines after any maintenance work has been carried out to avoid larger debris to enter the filters.
- If you plan to not use the product for an extended period of time, close the 3-way valve. Before using the product again, open the 3-way valve and allow the water to run through the faucet for 3 to 5 minutes.

USING THE PRODUCT

Buttons

button (Reset)	Press after replacing filters (see chapter MAINTENANCE).
button (Flush)	Press to flush newly installed filters.

Signals

Filter indicator lights	When blinking, indicate it is time to change filters.
-------------------------	---

Modes

Safety mode	The product automatically switches off if water runs continuously for 30 mins. To reset, close the faucet, power off few minutes. Power up again, The product returns to normal.
Auto-cleaning mode	The product is cleaning the filters.

Start up

1. Connect the adapter and faucet to the unit cable connector then connect the plug to a 110-240V GFCI power outlet.
2. All indicators on the front panel blink simultaneously for 5 seconds , After this the system is starting up. The main unit will enter the auto-cleaning mode for 25 seconds. Do not use faucet during this time.
3. After the product has completed its auto-cleaning mode, it is recommended to open the connected faucet and allow water to run for at least 20 minutes to flush the filters before drinking the water for the first time.

Use

1. Slowly turn the handle of the faucet from its upright position 90° anti-clockwise to start the flow of water.
2. Turn the handle of the faucet 90° clockwise to stop the flow of water.

NOTICE The amount of purified water depends on water pressure and water temperature.

MAINTENANCE (FILTER REPLACEMENT)

1. To change a filter, proceed as follows:

2. Close the 3-way valve.

3. Open the drinking water faucet to release pressure.

4. Disconnect the plug from power outlet.

5. Remove the cover (front or back), from the main unit.

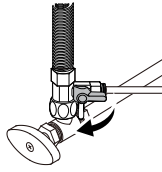

6. Move up the locking handle and Pull out filter from the unit.

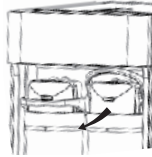

7. Insert new filter (The bottom of the filter should be inserted into the base of the unit).

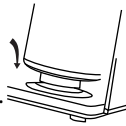

8. Align the filter nozzles with ports of the system then pull down the locking handle.

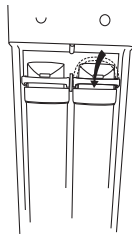

9. Install the cover.

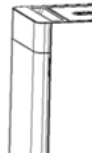

NOTICE

- The filters need to be replaced when the corresponding indicator start to blink prompting filter replacement
- Both filters have a limited service life.
- Changes in taste, odor and color can also indicate manual filter replacement is required.

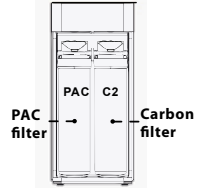

NOTICE

Please make sure the PAC filter on the left side and the Carbon filter is on the right side, these positions are not interchangeable. (Fig. 16)

PROMPTED FILTER REPLACEMENT

10. After the product has completed its start up, press and hold the button (Reset) for 3 seconds.
11. Open the systems faucet and allow water to run for at least 20 minutes to flush filters before drinking the water for the first time.
12. Press the (Flush) button to flush newly replace filters.

MANUAL FILTER REPLACEMENT

13. Press the button (Reset) to select the filter to be replaced. A blinking indicator signals which filter has been selected.
14. Once the correct filter is selected, press and hold the button (Reset) for 3 seconds until the indicator of the selected filter remains on.
15. Press the (Flush) button to flush newly replace filters.

NOTICE

Any other service not mentioned in this manual should be performed by an authorized dealer.

TROUBLESHOOTING

Problem	Possible causes	Solution
Decreased flow of purified water.	The 3-way valve is not fully open.	Fully open the 3-way valve .
	The filter is blocked or has reached the end of its life cycle.	Replace the filter.
Change in water taste.	The filter was not used for several days.	Turn on the faucet and allow the water to run for 5 minutes.
	The filter has reached the end of its life cycle or is defective.	Replace the filter.
The purified water contains a high level of total dissolved solids (TDS).	The level of TDS in the water supply exceeds the maximum level permitted by the EPA for public drinking water.	Immediately stop using the product and close the 3-way valve to avoid damage.
		Install a pretreatment device ahead of this product in the water supply. Reinstall the product.
The main unit is leaking.	System component failure	Close the 3-way valve and disconnect the plug from the power outlet. Immediately contact customer support.
	Filters not installed correctly	Close the 3-way valve . Remove and refit the filters. Open the 3-way valve.
There is no purified water coming out of the connected faucet.	The water leakage detector has been triggered.	Close the 3-way valve and disconnect the plug from the power outlet. Inspect the lines and pipes for external leaks. Tilt the main unit to check for internal leaks: <ul style="list-style-type: none"> If leakage is internal, water will drain out from the main unit. Contact customer support. If the leakage is external, inspect for leaks and fix the leak accordingly. Drain any water from main unit by tilting it. Reset the leakage detector: disconnect the plug from the outlet. Disconnect the tap - water PE-tube (BLUE). Reconnect the tap-water PE-tube (BLUE) to the Tap-water inlet, and connect the plug to the power outlet.
		An air bubble is blocking the PE-tubes (usually after a filter replacement or water supply shutdown).

CLEANING

- Before cleaning, disconnect the product from the power supply.
- Do not use any aggressive cleaners, brushes with metal or nylon bristles, or sharp or metallic cleaning utensils such as knives, hard scrapers, and the like. They could damage the surfaces.
- Use a damp cloth to wipe off the of the product. Let the product dry completely.

SPECIFICATIONS

Model.....	IntelliClear RO600
Rated voltage.....	100-125 V AC
Rated frequency	50/60Hz
Rated current	4 A
Power consumption	75W
Protection class	Class II
Inlet water source.....	Municipal tap water
Inlet water pressure	14-100 psi
Operating and storage temperature	40-100 °F (4-38 °C)
Inlet water temperature	40-100 °F (4-38 °C)
Product dimensions (H x W x D).....	14.3x6.5x13.2" (365x165x335mm)
Gross weight	20.2lbs (9.2kg)
Net weight	16.5lbs (7.5kg)

Recommended Water Quality

Specifications	Limits
Total Dissolved Solids (TDS)	up to 750 ppm
Turbidity	up to 1 NTU
Iron (Fe)	up to .05 ppm
Inlet water pressure	14-100 psi
Inlet water temperature	40 - 100°F (4 - 38°C)

NOTICE The output amount of purified water depends on the inlet water pressure and temperature.

DISPOSAL

Disposing of the product

Should the product no longer be capable of being used at some point in time, dispose of it in accordance with the regulations in force in your city or county. Ensure your recycling information applies to the local regulations.

The product is subject to change without notice.

1 YEAR LIMITED WARRANTY

This is the only express warranty for the product and in lieu of any other warranty or condition.

This product is warranted to be free from defects in material and workmanship for a period of one year from the date of original purchase. During this period, your exclusive remedy is repair or replacement of this product or any component found to be defective, at our option; however, you are responsible for all costs associated with returning the product to us and our returning the product or component under this warranty to you. If the product or component is no longer available, we will replace with a similar one equal or greater value.

This warranty does not cover wear from normal use, and operation doesn't conform to the instruction manual, or damages to the product resulting from accident, alteration, abuse, or misuse. This warranty extends only to the original consumer purchaser, or gift recipient. Keep the original sales receipt, as proof of purchase is required to make a warranty claim. This warranty is void if product is used for other than single-family household use or subjected to any voltage and waveform other than as specified on the label.

We exclude all claims for special, incidental, and consequential damages by breach of express or implied warranty. All liability is limited to amount of the purchase price. Every implied warranty, including any statutory warranty or condition of merchantability or fitness for particular purpose, is disclaimed except to the extent prohibited by law, in which case such warranty or condition is limited to the duration of this written warranty.

This warranty gives you specific legal rights. You may have other legal rights that vary depending on where you live. Some states or provinces do not allow limitations on implied warranties or special, incidental consequential damages, so the foregoing limitations may not apply to you.

Customer Service Phone: 1-877-781-8777

INTELLI CLEAR[®]

