

HydroFlexUV[®]

**Point of Use water dispenser utilizes filtration
and UV process sterilization**

USER MANUAL



Rated Power: 520W
Voltage: 115V
Frequency: 60Hz

Table of Contents

Indicator Lights, Pushbuttons & Working Principle-----	1
Set Up -----	2
Filter Preparation & Installation -----	2
Filter Replacement & Installation -----	4
Install Safety Brackets -----	5
Operation Instructions -----	6
Part Description -----	9
Outside & Inside Cleaning -----	10
Deep Cleaning -----	12
Trouble Shooting -----	15
Warnings and Safety Precautions -----	16
Technical Parameters & Warranty Information -----	17
1 Year limited warranty -----	17

WARNING

ELECTRICAL REQUIREMENTS

A 115 V, 60 Hz, AC only, 15 A or 20 A fused, grounded electrical supply is required. It is recommended that a separate circuit serving only your water dispenser be provided. Use an outlet that cannot be turned off by a switch. Do not use an extension cord.

Indicator Lights, Pushbuttons & Working Principle

INDICATOR LIGHTS:

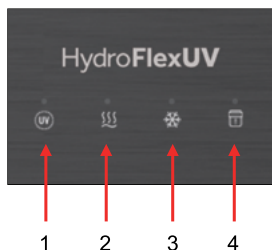

1	UV LED
2	Heating LED
3	Cooling LED
4	Filter Replacement Reminder LED

PUSHBUTTONS:

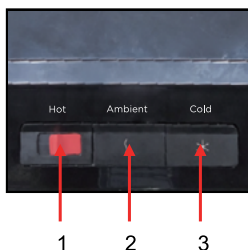

1	Hot Water Pushbutton
2	Room Temperature Pushbutton
3	Cold Water Pushbutton

Working Principle

1.Flowchart of water generation

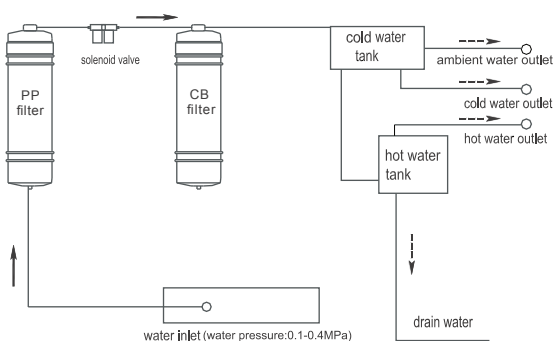

2.Circuit diagram

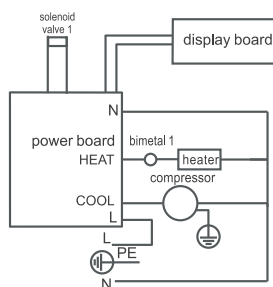

Filter function introduction

Stage	Filter	Function
Stage 1	PP filter	Removes silt, sand, rust, dirt, and other undissolved particles.
Stage 2	CB filter	Reduces aesthetic impurities such as chlorine and taste/odor.

Set Up

POSITIONING DISPENSER

Notice: Do NOT plug power cord into wall outlet until instructed.

1. Place dispenser upright. NOTE: If dispenser has been laid on its side, please allow it to remain upright for at least 24-hours prior to use.
2. Locate dispenser on a hard and level surface in a cool shaded location near a dedicated receptacle.
3. Locate dispenser close to a main water supply.
4. Position dispenser so the back is at least 4 inches from wall and there is at least 4 inches of clearance on both sides.

INSTALL DRIP TRAY & COVER

1. Remove drip tray and cover from protective packaging.
2. Slide drip tray assembly into position and secure.

Filter Preparation & Installation

Notice: Before installing the carbon block water filter into the water dispenser, the filter will need to be flushed with fresh clean water. Please use the Filter Flushing Kit provided with your water dispenser.

Filter Flush Kit Installation

Install the Cold-Water Supply:

1. As shown in the illustration to the right, locate the closest cold-water supply shut-off valve and turn off the water supply valve. NOTE: open the cold-water faucet to release the water pressure.
2. Before disconnecting the cold-water supply line, have a bucket and towel ready to capture any water left-over in the water supply line.
3. Disconnect the existing cold-water line from the water shutoff valve.
4. Inspect the water supply fittings to make sure that the gasket inside the female threaded portion of the fitting.
5. Inside the filter flush kit is a Water Supply Fitting. This water supply fitting will connect between the cold-water line and cold water shut-off valve.
6. Before installing the water supply fitting onto the male threaded portion of the cold water shut off and cold water line, be sure to wrap the male thread with thread-tape.
7. Install the water supply fitting and connect cold water line to water supply, be careful not to cross-thread or over-tighten the fitting.

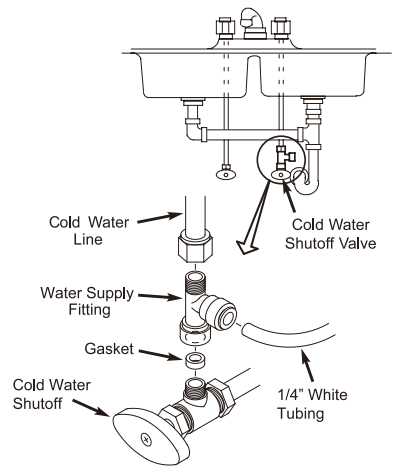

Cold Water Supply Connection
(using included water supply fitting)

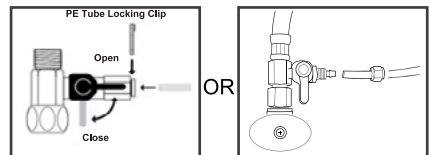

Install the Filter Flush Kit

1. Referring to the illustration to the right; connect the white PE tube to the newly installed water supply fitting.
2. Connect the other end into the filter head
3. Insert the active carbon filter into the filter flushing tip, tighten it by turning the filter counter clockwise.
4. On the other side of the filter head, connect another white PVC tube into the filter head. Note: This PE tube will need to be long enough to reach a sink drain and the location of your water dispenser. Carefully secure the end of the PE tube so water does not spill outside the sink.
5. Turn ON the main water supply and water supply fitting to flush the filter. Note: you will see a discharge of black water, this is normal and will clear after 10 minutes of flushing.

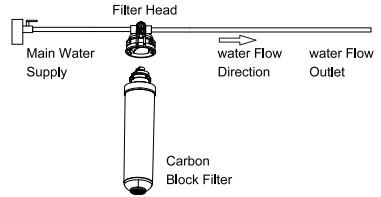

Install the Sediment (PP) & CB Filters

NOTE: After flushing the carbon block filter, the carbon block filter will hold residual water after being flushed, this is normal.

1. Install the Sediment (PP) filter and clean carbon block (CB) filter into the base of the water dispenser. From left to right, install the PP filter and then the CB filter.
2. Carefully install the filter by sliding the filter cartridge into the filter head and twisting the filter counter clockwise to lock into place. *NOTE: For ease of installing the filter cartridge, the filter head is designed to pivot up.*

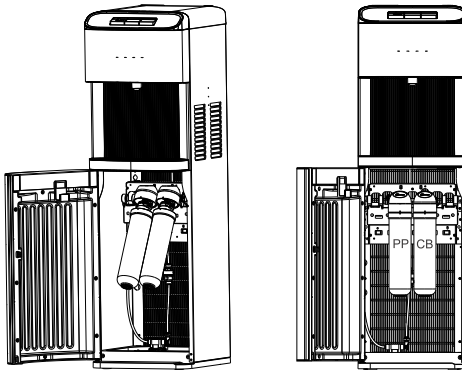

3. Once both filters are installed, remove the protective plug from the lower right back of the unit, reference picture. To do this press on the push connect ring that is behind the plug. Push the open end of the PE Tubing into the water inlet. Make sure the PE Tubing is tight and secure, refer to the figures below.

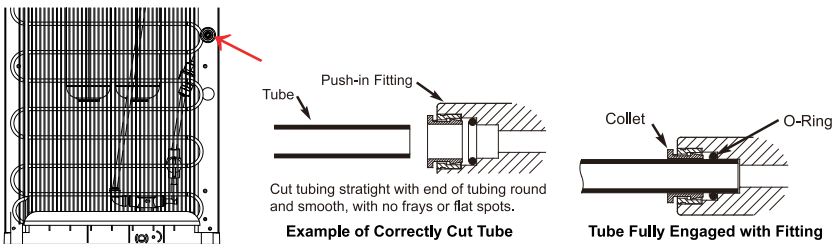

4. Located behind the lower cabinet door is the water dispenser on/off water valve. Turn on the Valve that is located to the left of the filters inside of the cabinet (the on position is parallel to the PE Tubing).

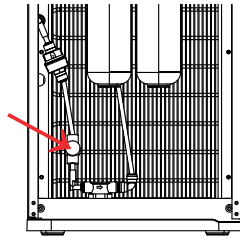

5. Install the white PE water supply line from the sink and turn on the main water supply. Check for leaks. Note: water will not start to fill the water reservoirs until the unit is plugged into the wall.

6. Plug dispenser into a dedicated GFCI outlet. At this time, you will hear water starting to fill the hot and cold tanks. It will take up to 4-minutes to fill the tanks for the first time. During this period, water will run continuously. This is normal. *NOTE: The dispenser is intended to be plugged into a (GFCI) ground fault circuit interrupting receptacle.*

Filter Replacement & Installation

1. When replacing a filter, please unplug the water purifier and turn off the main water supply under the sink and the water dispenser on/off water valve. Note: some water will drip and spill out from the filter connections, have bucket and towel ready to clean up any spills of water.
2. Before installing new filter, **remember to flush out the filter as described in the section titled, "Install the Filter Flush Kit"**.
3. When new filter is flushed, install the new filter, turn on the main water and water dispenser water valves and plug dispenser into a dedicated GFCI outlet.
4. Check for leaks.
5. *Note: Your water dispenser is equipped with a water leak detector, located inside the cabinet. When replacing filters, make sure this area is dry and not filled with water. Reference Leak Detector instructions for more information.*

Filter Replacement

This system features an LED filter replacement indicator. Please change both filters if the indicator lights up.

Both filters have a limited service life. Changes in taste, odor, color and flow of the water dispensed by the unit may also indicate that the filters must be replaced.

PP filter	CB filter
-----------	-----------

Install Safety Brackets

⚠ WARNING To prevent the water dispenser from tipping, please install the enclosed safety bracket.

- 1-2. Loosen the screw of the left or right bottom angle just as the picture shown.
3. Use the screw to fix the bracket on the left or right bottom angle of the water dispenser.
4. Make a hole on the floor's or the desk's surface where the water dispenser will be installed.
5. Fix the bracket on the floor by screw tightly.
6. Tighten the screw.

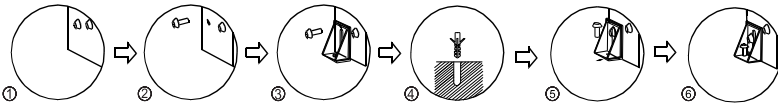
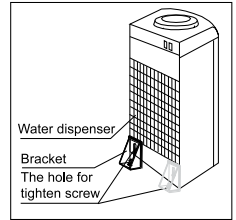

PLUG INTO A GROUNDED ELECTRICAL OUTLET

Plug power cord into a properly grounded wall outlet.

At this time, you will hear the water running and start filling the water reservoirs with water. It will take approximately 4 to 5 minutes to fill the water reservoirs for the first time. During this period, the water will run continuously, this is normal.

ACTIVATE THE HEATING AND COOLING SWITCHES

NOTE: Do NOT turn on the cooling and heating switches until the water bottles is connected to the dispenser and ready to be used.

Activating switches prior may cause damage to dispenser.

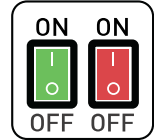

1. Do NOT turn ON switches until water is plumbed and ready to be used.
2. To activate the cooling and heating system, press the two switches on the back of the water purifier. See illustration.
3. Notice: the green switch will turn on or off the cooling system and the red switch will turn on or off the heating system.
4. Once the switches are activated, both the cooling and heating lights on the front panel should turn on.

ACTIVATE NIGHT LIGHT

1. Press the blue switch to turn light on.
2. To turn off, press the blue switch to turn light off.

Operation Instructions

This water dispenser has been tested and sanitized prior to packing and shipping. During transit, dust and odors can accumulate in the tank and lines. Dispense and dispose at least one quart of water prior to drinking any water. 35mL

Dispensing Cold Water Temperature: (37°F - 50°F / 3°C - 10°C)

Tank Capacity: 1 gallon, Flow Rate: .375 GPH

After setup, cold water will be available in approximately 1-hour. During this time, the compressor will run continuously. This is normal.

Dispensing Hot Water Temperature: (176°F – 199°F / 80°C – 95°C)

Tank Capacity: .26 gallons Flow Rate: .375 GPH

⚠ WARNING *This unit dispenses water at temperatures that can cause severe burns. Avoid direct contact with hot water. Keep children and pets away from unit while dispensing. Never allow children to dispense hot water without proper and direct supervision. Unplug unit to prevent unsupervised use by children.*

After setup, hot water will be available in 15 – 20 minutes. During this time, the heating system will start to boil the water inside the tank. This is normal.

WARNINGS & SAFETY PRECAUTIONS

To reduce risk of injury and property damage, user must read this entire guide before assembling & operating dispenser.

Failure to execute the instructions in this manual can cause personal injury or property damage.

Models that heat water dispense at very high temperatures. Failure to use properly can cause person injury.

When operating this dispenser, always exercise basic safety precautions, including the following:

- Prior to use, this dispenser must be properly assembled and installed in accordance with this manual.
- This dispenser is intended for water dispensing only. Do NOT use other liquids. Do NOT use outdoors.
- For indoor use only. Keep water dispenser in a dry place away from direct sunlight. Do NOT use outdoors.
- Install and use only on a hard, flat and level surface.
- Do NOT place dispenser into an enclosed space or cabinet.
- There must be at least 4 inches clearance on the sides of the dispenser to permit airflow.
- The dispenser is intended to be plugged into a ground fault interrupting receptacle.
- Do NOT use an extension cord with your water dispenser.
- Do NOT use this dispenser if cord becomes frayed or otherwise damaged.
- To protect against electric shock, do NOT immerse cord, plug or any other part of dispenser in water or other liquids.

Cold Water Dispense Push Button

How to Dispense Cold Water:

1. Place bottle, glass, pitcher or cooking pot below water outlet spout.
2. Press cold water dispense button to dispense cold water (Dark Blue Button).
3. Release button to stop dispensing water.
4. Water will take approximately 1-hour after initial set up to reach its coldest temperature. You will see the cold-water cooling icon on the front panel turn on and hear the compressor turn on. Once the water has been fully chilled, the cooling icon and compressor will turn off.



Red - Hot Water Button

∫ - Room Temp Button

* - Cold Water Button

Room Temperature Water Dispense Push Button

How to Dispense Room Temperature Water:

1. Place bottle, glass, pitcher or cooking pot below water outlet spout.
2. Press room temperature dispense button to dispense room temperature water. (Light Blue Button)
3. Release button to stop dispensing water.

Hot Water Dispense Push Button

How to Dispense Hot Water:

1. Water will take approximately 15-minutes after initial set up to reach its hottest temperature. Note: The hot water heating icon will turn on to indicate water is heating. You may hear water boiling inside the hot tank, this is normal.

⚠ WARNING *This unit dispenses water at temperatures that can cause severe burns. Avoid direct contact with hot water. Keep children and pets away from unit while dispensing. Never allow children to dispense hot water without proper and direct supervision. Unplug unit to prevent unsupervised use by children.*

2. Place bottle, glass, pitcher or cooking pot below water outlet spout.
3. To dispense hot water, slide the red child safety lock to the left and depress the button to dispense hot water.
4. Release button to stop dispensing water.

Water Filter Reset Button

How to Reset the Water Filter:

1. The water filter reset switch is located on the back left side of the top cover.
2. The Water Filter Replacement Reminder indicator light will flash on and off when the water filter life cycle is completed.
3. Replace the filters, reference section, "Filter Replacement & Installation" for more details.

The Display Panel is Shown on the Right

The display panel is shown to the right has four display indicators. From the left to right the indicators are: UV Indicator, Heating Indicator, Cooling Indicator & Filter Replacement Reminder Indicator.

Display Panel Indicator Functions:

1. UV Indicator: The UV indicator light will flash on and off when the water dispenser is first powered on. When the UV sterilization module is working, the UV sterilization indicator is always on, and when the UV sterilization module stops working, the UV sterilization indicator turns off.
2. Heating Indicator: The heating indicator turns on when heating and turns off when hot water reaches set temperature.
3. Cooling Indicator: The cooling indicator turns on when cooling and turns off when cold water reaches set temperature.
4. Filter Replacement Reminder Indicator - When the filter life expires, the filter replacement reminder indicator flashes on and off. To turn off and reset the reminder indicator, press and hold the filter reset switch for 3-seconds, located on the top of the back panel left side. You will hear a beep and the filter replacement reminder indicator will turn off.

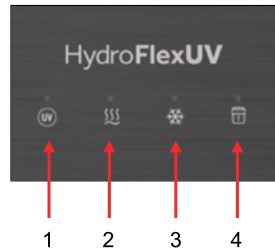

⚠ WARNING

- UV light source. Disconnect the electrical supply to the UV radiation BEFORE opening cover.
- UV-LED lamp must be repaired by manufacturer only.
- UV-LED lamp model no. YB09-950-022, rated DC 24V, 0.17W±20%.
- Disposal of the UV-LED lamp must be done in accordance with local laws and regulations.

Leak Detector Instructions:

Note: Your water dispenser is equipped with a water spill leak detector.

1. The leak detector is located inside the lower back left corner of the cabinet. If water leaks inside the cabinet, the floor of the cabinet is designed to collect water.
2. If water fills this cavity, the leak detector will automatically stop water flow to the water dispenser.
3. If activated, please check around the machine for any leaking water and determine the source of it. If you find the source of the leak, you can call our support line for assistance in fixing it.
4. Note: If you do not find the source of this leak, it may have been caused by accidental spillage of water or from a filter change. If this occurred, dry area with towel.
5. If you do find a leak, unplug your water cooler and turn off main water supply.

Part Description

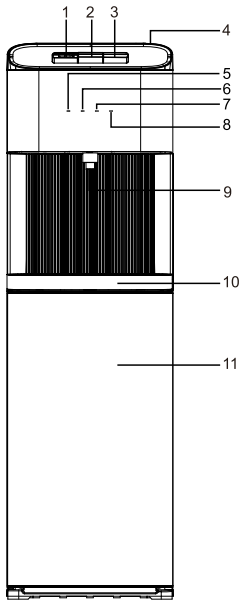

(FRONT)

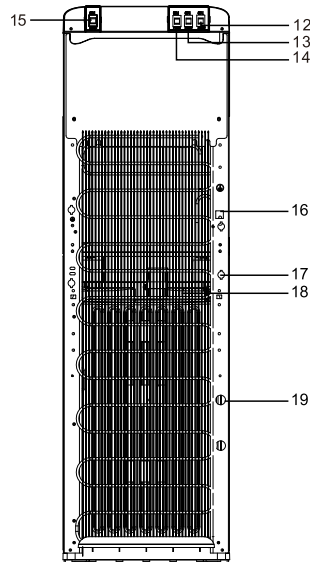

(REAR)

Part	Description
1	Hot Water Dispense Button
2	Room Temp. Dispense Button
3	Cold Water Dispense Button
4	Top Cover
5	UV indicator Light
6	Heating indicator Light
7	Cooling indicator Light
8	Filter element replacement reminder indicator Light
9	Water Faucet

Part	Description
10	Drip Tray
11	Door
12	Heating Switch
13	Cooling Switch
14	Nightlight Switch
15	Filter element reset switch
16	Power Supply Cord
17	*Drain Outlet Plug
18	Condenser
19	Water Inlet

*Drain Outlet Plug Caution:

⚠ WARNING *Before removing the Drain Outlet Plug, allow the water dispenser to sit and cool down for 45-minutes. The water will drain directly from the hot tank, if water is not properly cooled, this unit dispenses water at temperatures that can cause severe burns. Avoid direct contact with hot water. Keep children and pets away from unit while dispensing & deep cleaning. Never allow children to dispense hot water without proper and direct supervision. Unplug unit to prevent unsupervised use by children.

Outside & Inside Cleaning

⚠ WARNING To avoid electrical shock, the dispenser must not be cleaned by a water jet and unplug the water dispenser before performing the cleaning operation.

⚠ WARNING All cleaning procedures should be performed by an adult.

⚠ WARNING *This unit dispenses water at temperatures that can cause severe burns. Avoid direct contact with hot water. Keep children and pets away from unit while dispensing. Never allow children to dispense hot water without proper and direct supervision. Unplug unit to prevent unsupervised use by children.*

Rinsing, Cleaning & Draining

Notice: To prolong the lifetime of the water dispenser, it is recommended that the unit be cleaned and sanitized manually every six-months. The water cooler will hold approximately 4-liters of water

How to Clean the Outside of the Unit:

1. Clean your cabinet, controls, water bottle probe and water spout each time you change your water bottle. Use a clean soft cloth and a food grade sanitizer.
2. Remove and rinse out your drip tray with warm soapy water. Rinse completely and dry before using.

How to Clean the Inside of the Unit:

⚠ WARNING To avoid electrical shock, unplug the water dispenser before performing the cleaning operation.

NOTE: The machine has been disinfected prior to departing the factory. However, it is recommended to rinse and drain the unit prior to installation.

3. Unplug unit from wall.
4. Open cabinet door and carefully pull out water bottle.
5. Remove water bottle straw from water bottle and hang on door hanger.
6. Close door and place water bottle in a safe location.
7. Unscrew safety brackets from floor.
8. Carefully pull unit away from setup location, caution the unit is heavy.
9. Looking at the back top of the unit, remove the two screws from the top cover, see illustration below.
10. Lift up on the back edge of top cover and pull up, careful, the top cover is connected with wires.
11. Remove the plastic white cold tank cover from the cold water tank and internal white plastic separator.

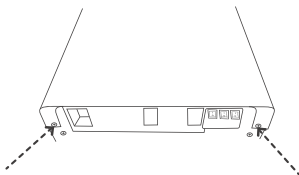

How to Clean the Inside of the Unit, Continued:

⚠ WARNING Before removing the Drain Outlet Plug, allow the water dispenser to sit and cool down for 45-minutes. The water will drain directly from the hot tank, if water is not properly cooled, this unit dispenses water at temperatures that can cause severe burns. Avoid direct contact with hot water. Keep children and pets away from unit while cleaning. Never allow children to dispense hot water without proper and direct supervision. Unplug unit to prevent unsupervised use by children.

12. Notice: If the unit has water inside the cold tank, skip to step 14.
13. Pour a half gallon of clean water into the cold tank. (The cold tank is the open cylinder that the plastic white cover was removed from.)
14. Place a 5-gallon bucket under the drain outlet plug located on the back of the unit.
15. Remove the drain cover and plug, water will start to drain from the unit. Note: Water will start flowing as soon as the drain cover is removed, see illustration below.

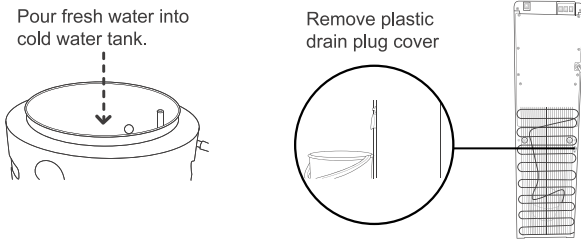

16. When water stops draining, install the drain plug, it is not necessary to re-install the plastic drain plug cover at this point.
17. Note: If you skipped to step 14, go back to step 13 and follow the instructions.
18. Reinstall the cold water tank internal seperature and top cover. Make sure the top cover snaps onto cold water tank.
19. Check to make sure wires did not get pinched under cold water tank cover. If wires are pinched, carefully remove the top cover and reinstall.
20. Reinstall the top cover with the two screws.
21. Slide the unit back into place and reinstall the safety brackets to the floor.
22. Insert water bottle straw into water bottle and carefully slide water bottle into cabinet.
23. Close door and plug unit into a GFCI wall outlet.
24. Turn on cooling and heating system as described.

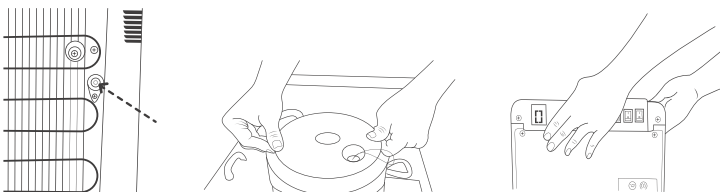

Deep Cleaning

Notice: Keeping your water cooler clean provides you the best chance of benefitting from all the watery goodness without any contamination. Deep cleaning every 6-months will help to remove mineral deposits from the water systems.

⚠ WARNING To avoid electrical shock, unplug the water dispenser before performing the cleaning operation.

⚠ WARNING All cleaning procedure should be performed by an adult.

⚠ WARNING *This unit dispenses water at temperatures that can cause severe burns. Avoid direct contact with hot water. Keep children and pets away from unit while dispensing. Never allow children to dispense hot water without proper and direct supervision. Unplug unit to prevent unsupervised use by children.*

Deep Cleaning Steps:

1. Unplug unit from wall.
2. Open cabinet door and carefully pull out water bottle.
3. Remove water bottle straw from water bottle and hang on door hanger.
4. Close door and place water bottle in a safe location.
5. Unscrew safety brackets from floor.
6. Carefully pull unit away from setup location, caution the unit is heavy.
7. Looking at the back top of the unit, remove the two screws from the top cover, see illustration below.
8. Lift up on the back edge of top cover and pull up, careful, the top cover is connected with wires.
9. Remove the plastic white cold tank cover from the cold water tank and internal white plastic separator.

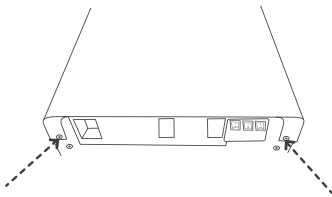

⚠ WARNING *Before removing the Drain Outlet Plug, allow the water dispenser to sit and cool down for 45-minutes. The water will drain directly from the hot tank, if water is not properly cooled, this unit dispenses water at temperatures that can cause severe burns. Avoid direct contact with hot water. Keep children and pets away from unit while dispensing & deep cleaning. Never allow children to dispense hot water without proper and direct supervision. Unplug unit to prevent unsupervised use by children.*

Deep Cleaning Steps, continued:

10. Remove the drain cover and plug, water will start to drain from the unit. Note: Water will start flowing as soon as the drain cover is removed, see illustration below.

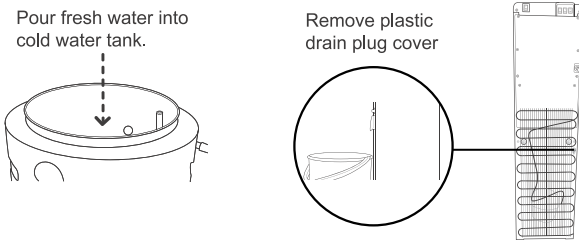

11. When water stops draining, re-install the drain plug and drain cover.

Prepare Citric Acid or Vinegar Solution:

Notice: The water cooler will hold approximately 1 gallon of water, follow the recommended instructions on how to prepare the citric acid or vinegar solution.

1. Pour the prepared solution of water into the cold tank. (The cold tank is the open cylinder that the plastic white cover was removed from.)
2. Re-install the plastic white cold tank cover. Make sure the cover is seated properly to the cold water tank. Note: Make sure the wires are not pinched when installing the plastic cover.
3. Note: The internal white plastic separator does not to be installed at this time.
4. Place the top cover into position. It is not necessary to completely install the top cover at this point.
5. Plug the unit into the wall and follow "How to Heat Water" steps.

How To Heat Water:

⚠ WARNING Hot Water will be extremely hot and produce severe scalding, never let children dispense water without direct adult supervision.

- After set-up, it will take 15 to 20 minutes to get water to maximum hot temperature. During this time the compressor will run continuously, this is normal.
1. Place bottle, glass, pitcher or cooking pot below water outlet spout.
 2. Slide the red toggle to the left and depress the button to dispense hot water.
 3. Release button to stop dispensing water.



Citric Acid or Vinegar Solution Working Time:

1. Heating hot water will take approximately 15-minutes to boil. When the water is heated to temperature, allow the water solution to sit an additional 10-minutes. This will allow the solution to deep clean the cold and hot tank thoroughly.

Deep Cleaning Steps, continued:

⚠ WARNING Before removing the Drain Outlet Plug, allow the water dispenser to sit and cool down for 45-minutes. The water will drain directly from the hot tank, if water is not properly cooled, this unit dispenses water at temperatures that can cause severe burns. Avoid direct contact with hot water. Keep children and pets away from unit while dispensing & deep cleaning. Never allow children to dispense hot water without proper and direct supervision. Unplug unit to prevent unsupervised use by children.

2. Unplug the unit from the wall.
3. Place a 5-gallon bucket under the drain outlet plug located on the back of the unit.
4. Remove the drain cover and plug, water will start to drain from the unit. Note: Water will start flowing as soon as the drain cover is removed, see illustration below.

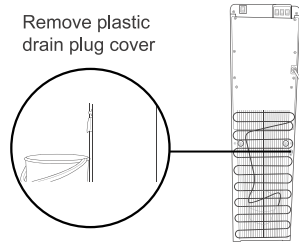

5. When water stops draining, re-install the drain plug and drain cover.
 6. Reinstall the cold water tank internal separator and top cover. Make sure the top cover snaps onto cold water tank.
 7. Check to make sure wires did not get pinched under cold water tank cover. If wires are pinched, carefully remove the top cover and reinstall.
 8. Reinstall the top cover with the two screws.
 9. Slide the unit back into place and reinstall the safety brackets to the floor.
 10. Insert water bottle straw into water bottle and carefully slide water bottle into cabinet.
 11. Close door and plug unit into a GFCI wall outlet.
 12. Turn on cooling and heating system as described.
- start flowing as soon as the drain cover is removed, see illustration below.

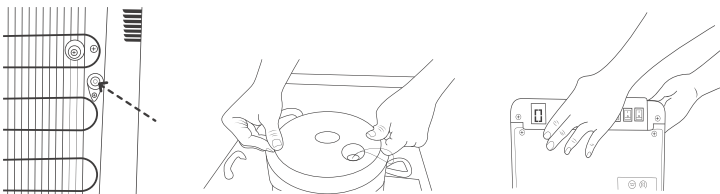

Trouble Shooting

Problem	Possible Cause	Suggested Solution
Small water flow or no water flow	Low water pressure	Check inlet water supply line and water valve is in ON position. Check PE tube for kinks, straighten
	Filters need replacement	Reference manual on How to Replace Filters
	Leak detector activated	Inspect for water leaks inside lower compartment, if water is present, turn off water valve and inspect.
Unsuitable Water Temperature	Over consumption of water in a short period of time	If cold water temperature is warm, allow cooling system to chill water to set temperature. If hot water temperature is cold, allow heating system to heat water to set temperature.
	Cooling or Heating Switch in OFF position	Turn on cooling or heating switch
	LEDs on the front panel are not ON.	Water dispenser is unplugged or circuit breaker is tripped.
Water Leakage	PE tube not connected properly	Check all water connections to make sure the PE tube is completely inserted into water connector.
	Water pipe and/or PE pipe broken	Replace broken pipes
Noisy Operation	Vibrations or abnormal noises	Check base and make sure water dispenser is on a steady and level surface
Machine will not turn on	LEDs on the front panel are not ON.	Water dispenser is unplugged or circuit breaker is tripped.

Warnings and Safety Precautions

To reduce risk of injury and property damage, user must read this entire guide before assembling & operating dispenser.

Failure to execute the instructions in this manual can cause personal injury or property damage.

Models that heat water dispense at very high temperatures. Failure to use properly can cause person injury.

When operating this dispenser, always exercise basic safety precautions, including the following:

- Prior to use, this dispenser must be properly assembled and installed in accordance with this manual.
- This dispenser is intended for water dispensing only. Do NOT use other liquids. Do NOT use outdoors.
- For indoor use only. Keep water dispenser in a dry place away from direct sunlight. Do NOT use outdoors.
- Install and use only on a hard, flat and level surface.
- Do NOT place dispenser into an enclosed space or cabinet.
- There must be at least 4 inches clearance on the sides of the dispenser to permit airflow.
- The dispenser is intended to be plugged into a ground fault interrupting receptacle.
- Do NOT use an extension cord with your water dispenser.
- Do NOT use this dispenser if cord becomes frayed or otherwise damaged.
- To protect against electric shock, do NOT immerse cord, plug or any other part of dispenser in water or other liquids.
- If the supply cord is damaged, it must be replaced by an original manufacture part. Please contact customer service.

⚠ WARNING To avoid electrical shock, unplug the water dispenser before performing the cleaning operation.

⚠ WARNING All cleaning procedure should be performed by an adult.

⚠ WARNING *This unit dispenses water at temperatures that can cause severe burns. Avoid direct contact with hot water. Keep children and pets away from unit while dispensing. Never allow children to dispense hot water without proper and direct supervision. Unplug unit to prevent unsupervised use by children.*

⚠ WARNING *Before removing the Drain Outlet Plug, allow the water dispenser to sit and cool down for 45-minutes. The water will drain directly from the hot tank, if water is not properly cooled, this unit dispenses water at temperatures that can cause severe burns. Avoid direct contact with hot water. Keep children and pets away from unit while dispensing & deep cleaning. Never allow children to dispense hot water without proper and direct supervision. Unplug unit to prevent unsupervised use by children.*

Technical Parameters & Warranty Information

MODEL	HydroFlex UV
Voltage / Frequency / Current	115V / 60Hz / 6A
Rated Power	520W
Heating Power	420W
Refrigerating Power	100W
Water Flow Rate	0.31gal/min(43.51psig)
Hot Water Capacity	.26gal/h(≥185°F)
Cold Water Capacity	1 gal/h(≤50°F)
Applicable Environment	39.2°F-100.4°F humidity ≤90%
Applicable Water Pressure	14.5-60psig
Applicable Water	Tap water
Stage 1	PP filter
Stage 2	CB filter
System Dimensions	15.2" x 14.0 x 43.9"

1 YEAR LIMITED WARRANTY

This is the only express warranty for this product and is in lieu of any other warranty or condition.

This product is warranted to be free from defects in material and workmanship for a period of one (1) year from the date of original purchase. During this period, your exclusive remedy is repair or replacement of this product or any component found to be defective, at our option; however, you are responsible for all costs associated with returning the product to us and our returning the product or component under this warranty to you. If the product or component is no longer available, we will replace with a similar one of equal or greater value.

This warranty does not cover wear from normal use or operation that does not comply with the instruction manual of damages to the product resulting from accident, alteration, abuse, or misuse. This warranty extends only to the original consumer purchaser or gift recipient. Keep the original sales receipt, as proof of purchase is required to make a warranty claim. This warranty is void if product is used for other than single-family household use or subjected to any voltage and waveform other than as specified on the label.

We exclude all claims for special, incidental, and consequential damages by breach of express or implied warranty. All liability is limited to amount of the purchase price. Every implied warranty, including any statutory warranty or condition of merchantability or fitness for particular purpose, is disclaimed except to the extent prohibited by law, in which case such warranty or condition is limited to the duration of this written warranty.

This warranty gives you specific legal rights. You may have other legal rights that vary depending on where you live. Some states or provinces do not allow limitations on implied warranties or special, incidental consequential damages, so the foregoing limitations may not apply to you.

Customer Service Phone: 1-877-781-8777

HydroFlexUV®

