



Service Manual



Made in USA



This valve is Tested and Certified by NSF International against NSF/ANSI Standard 44 for materials and structural integrity requirements

COMPONENT



Table of Contents

1. Introduction	4
2. Product Features and Applications	5-6
3. Product Dimensions and Specifications.....	7-8
4. Pre-Installation Checklist.....	9-10
5. Valve Installation	11-14
a. Control Valve Installation.....	11-12
b. System Sizing Chart.....	13
c. Control Valve Configuration.....	14
6. Ceramic Bypasses.....	14-15
7. Programming.....	16-24
a. Display and Instructions.....	16-17
b. Programming Modes A-01 to A-07	18-24
8. PCB Functions and Connections.....	25-32
a. Overview	25
b. Signal Output.....	26
c. Signal Output Connector.....	27-29
d. Interlock	30
e. Alternating Interlock	30
f. Remote Handling Connector	31
g. Interlock Options.....	31
h. Using One Flow Meter with Interlock	32

9. System Installation	32-44
a. Plumbing Connections	32
b. Drain Line Installation	32
c. Brine Line and Brine Tank Installation.....	33-36
d. System Installation Chart	37
e. System Start-Up.....	38-39
f. Sanitization Procedure	40
g. Water Flow Diagrams	41-44
10. Assembly Drawings and Parts List.....	45-46
a. Valve Exploded View	45
b. Valve Parts List.....	46
11. Troubleshooting.....	47-49
a. Control Valve	47-48
b. Electronics.....	49
12. Replacement Parts.....	50
13. Accessories.....	51
14. Packing List.....	52-53
a. Valve.....	52
b. System.....	53
15. Warranty	53-54
16. System Configuration and Settings	55
17. Factory Default Settings	56
18. Contact Information.....	57



1. Introduction

Thank you for choosing a **Hankcraft Runxin RevV4 Ceramic Rotary Valve**. RevV4 valves are designed with high flow rates to handle any residential or light commercial application. They feature innovative, patented ceramic discs for ultimate performance and reliability. The discs are abrasion and corrosion resistant, extending the life of the valve and significantly reducing maintenance costs.

RevV4 valves have 7 advanced programming options with fully adjustable cycles to minimize water usage during regeneration. They utilize up-flow regeneration which efficiently washes the media, exchanging more grains per pound of salt. RevV4 valves have signal output for external devices, program functions that remain in long term memory, and 72-hour memory backup should a power outage occur, giving you the confidence that your customers are receiving a cost-effective, high-quality water treatment solution.

Hankcraft Runxin's RevV4 valves have an interlock function to connect multiple valves in series or in parallel. There is an alternate interlock function, used with twin demand systems and 3-way ball valves to supply treated water 24/7. The RevV4's simple, yet powerful user interface has an easy to read LCD display and the valve offers remote handling to accept input from a PLC or computer. Advanced work modes are available with adjustable settings and three different cycle sequences to get the exact configuration needed for any job.

RevV4 Valves Feature:

- Patented ceramic discs for longer life and reduced maintenance
- Highly configurable with easy to use program interface
- Long-term memory for program functions
- 72-hour memory backup
- 4 language options: English, Spanish, Chinese, French

2. Product Features and Applications

Primary Applications

Recommended for commercial and residential softening or demineralization water treatment systems.

- Softening System
- Iron Removal System
- Ion Exchange Equipment
- Boiler Softening Water Treatment
- RO Pre-treatment

Product Characteristics

Mechanical Components

The RevV4 uses internal ceramic discs which are corrosion and abrasion resistant to form a hermetic seal. Rotation of the upper disc aligns to the corresponding lower disc ports for Service, Backwash, Brine & Slow Rinse, Brine Refill and Fast Rinse modes.

Hard Water/No Hard Water Bypass

Up-flow regeneration with no hard water and hard water bypass options. This valve operates as a hard water bypass.

Excellent Flow Rate: 20 gpm @ 15 psi drop.

365-Day Usage Memory

Manual / Delayed Regeneration

Pressing  at any time results in an immediate manual regeneration.



Pressing and holding  for 3 seconds, when system is locked, results in a delayed regeneration at the preselected time.

Extended Power Outage Indicator

If outage exceeds 3 days, the time of day indicator “⌚” will flash 12:12. The current time of day needs to be re-set. All other set parameters remain stored in memory. The valve will resume to operate from the point of the power outage.

Three Regeneration Sequences

Lockout Function

Keypad will lock after 5 minutes without use. To access the parameter changes press and hold  and  simultaneously for 3 seconds to unlock.



LCD Display Screen

Advanced Valve and External Device Connections

- Interlock and Alternate Interlock
- Remote Handling
- Solenoid Valve

7 Regeneration Mode Options with Adjustable Cycle Times

Maximum Day Regeneration Interval

When the valve reaches the maximum programmed service days, without reaching the set service capacity, it will trigger a regeneration at the pre-programmed time of day. Regeneration(s) reset both the maximum day regeneration value and the service capacity value.

One Button to Change the Current Time

Pressing and holding the  button for 3 seconds, when system is locked, allows the current time of day to be adjusted.

Service Alarm

When the service alarm feature counts-down and reaches set point, (Selectable 30 day min to 900 day max in 30 day increments) the alarm will activate at 8pm. The alarm will sound for 2 minutes and then shut off automatically. To silence alarm within the 2 minute period, press any button. A service call message will then appear on the screen as a signal for the homeowner to contact a water treatment professional for routine service. To eliminate this message from the screen, unlock the valve programming by pressing the UP and DOWN arrows simultaneously until the padlock in the upper left corner of the screen disappears (approximately 3 seconds). Next, enter the programming menu by pressing the MENU/CONFIRM button once and then pressing the BACK/REGENERATION button once. The system will then go back to normal status and the operational days will re-start new count-down. Note: The system will operate normally when it is displaying the service alarm message.

3. Product Dimensions and Specifications

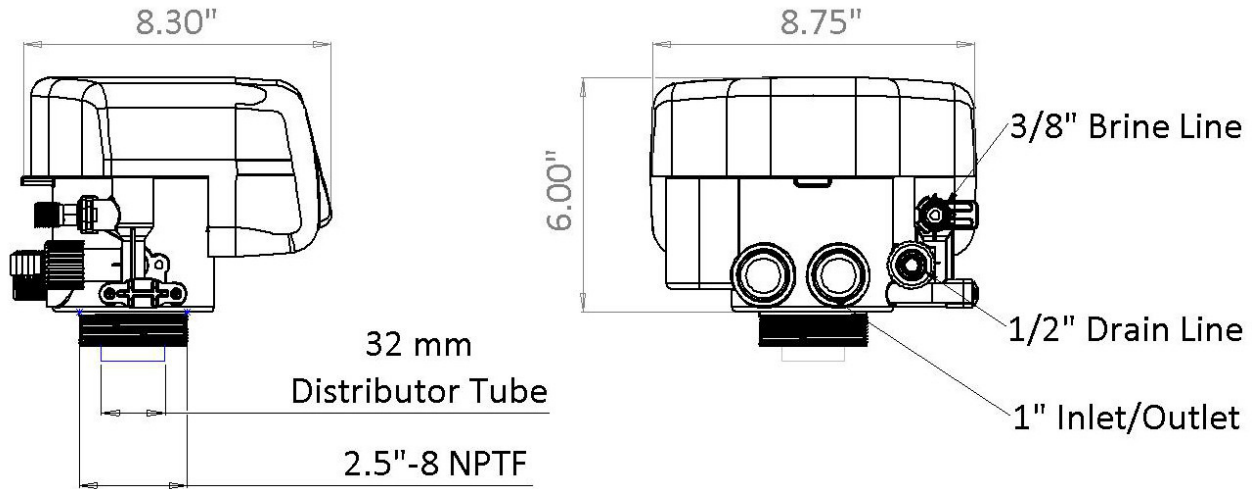

Length (max.)	Width (max.)	Height (max.)	Regeneration Mode
8.3"	8.75"	7.5"	Up-flow

These valve dimensions are for reference only.

Connect Port Dimensions							
Product Model	Inlet Port	Outlet Port	Drain Port	Brine Port	Base	Riser Pipe	Hard Water Bypass
72605-HK	1" NPT	1" NPT	3/4" NPT	3/8"	2.5" 8NPSM	32 mm	No
72605B-HK	1" NPT	1" NPT	3/4" NPT	3/8"	2.5" 8NPSM	32 mm	Yes
Main Technical Parameters							
Water Capacity	See Performance Data Sheet						
Power Input	100-240VAC / 50-60Hz						
Power Output	12VDC / 2A						
Regeneration Cycles	Sequence 1: Service → Backwash → Brine & Slow Rinse → Fast Rinse → Brine Refill Sequence 2: Service → Backwash → Brine & Slow Rinse → Backwash → Fast Rinse → Brine Refill Sequence 3: Service → Brine Refill → Service (180 min-time fixed) → Backwash → Brine & Slow Rinse → Backwash → Fast Rinse Sequence 4: Service → Backwash, Rinse, Air Draw and Slow Rinse						



Regeneration Mode	<p><u>A-01 Meter Delay:</u> Regeneration happens when the capacity reaches zero and the preset time of regeneration is reached.</p> <p><u>A-02 Meter Immediate:</u> Regeneration happens when the capacity reaches zero.</p> <p><u>A-03 Intelligent Meter Delay:</u> The same delay function as A-01 but the capacity is determined by entering the total Resin Capacity, Feed Water Hardness, and the Number of People in the household. The control valve automatically calculates the gallons for regeneration.</p> <p><u>A-04 Intelligent Meter Immediate:</u> The same function as A-02 but the capacity is determined by entering the Total Resin Capacity and Feed Water Hardness. The control valve automatically calculates the gallons for regeneration.</p> <p><u>A-05 Remaining Compare:</u> Compares current usage with previous 365 day daily usage to intelligently determine when regeneration will occur. Regeneration starts at the set regeneration time.</p> <p><u>A-06 By Day (timer):</u> Service days count down to zero (0) and regeneration starts at the set regeneration time.</p> <p><u>A-07 Filter Meter:</u> Filter mode, regeneration occurs when the capacity reaches zero and the preset time for regeneration is reached.</p>
-------------------	---

4. Pre-Installation Checklist

IMPORTANT NOTICE

Read through the instructions thoroughly and obtain all materials and tools before proceeding with the installation. Be sure to follow all applicable national, state, county and local plumbing codes and regulations.

All plumbing and electrical work should be performed by an accredited professional to ensure all local, state, and municipal guidelines are met.

During cold weather it is recommended that the installer warm the valve to room temperature before operating.

Required Operating Conditions

Working Conditions	Working Pressure	20psi ~ 120psi
	Water Temperature	35 °F ~ 125 °F
Working Environment	Environment Temperature	35 °F ~ 125 °F
	Relative Humidity	≤95%
	Power Source	100-240VAC / 50-60Hz
Inlet Water Quality	Turbidity	< 2FTU
	Hardness	50 grains per gallon or less
	Chlorine	< 0.1ppm
	Iron ²⁺	< 0.3ppm



Do not exceed 120 psi water pressure.
Do not exceed 35° C / 125° F water temperature.
Do not subject unit to freezing conditions.

Failure to use this product within the described conditions may void the warranty.





- Do not use the system with water that is microbiologically unsafe or of unknown quality without adequate disinfection before or after the system.
- Do not use the brine tube, injector body, or other connectors on the RevV4 valve as a handle to carry the system.
- Ensure there is salt in the brine tank at all times when this valve is used for softening. The brine tank should contain clean water softening salt only, at least 99.5% pure. Do not use small grain salt.
- When there is moderate to high turbidity, a filter should be installed before the water softening system on the inlet side.
- If the water pressure exceeds 120psi, a pressure reducing valve must be installed before the water inlet. If the water pressure exceeds 80 psi, installing a pressure reducing valve before the water inlet is highly recommended. If the water pressure is under 20 psi, a booster pump must be installed before the water inlet.
- Replacement parts for the RevV4 valve should only be purchased through Hankscraft Runxin resellers. Electrical components, such as transformers, are specific to the RevV4 valve from Hankscraft.
- Regular interval monitoring of the water quality and work environment is recommended to ensure proper operation of the valve and system.
- Any modification to Hankscraft equipment, which is outside the standard scope of supply, voids the product warranty.
- Hankscraft equipment, like all modern electronic devices, can be damaged by electrical surges or brown outs. Every effort has been taken to harden the circuits, by design, to protect against such events. These precautions, or even additional surge protection, are not 100% effective. Therefore, equipment damage caused by abnormal electrical events is not covered by warranty.

5. Valve Installation

Unit Location

- The filter or softener should be located close to a floor drain away from direct sunlight and any heat sources.
- Protect equipment from direct sunlight and precipitation exposure.
- Install equipment in a location safe from unauthorized access or vandalism.
- Ensure that the unit is installed with enough space for operation and maintenance.
- The installation surface should be clean and level.
- Install the unit in an environment which minimizes consumer risk of loss in the event of malfunction.
- Hancraft Runxin offers many different products for many different applications, for both indoor and outdoor environments. If you are not 100% sure the equipment purchased is suitable for the installation application or environment, please check with a Hancraft representative, or your local equipment provider, to ensure the proper equipment is selected. Equipment installed in inappropriate applications or environments are not covered by warranty.
- Brine tank should be installed close to the RevV4 control valve.

Plumbing and Mechanical Setup

-  *If the water outlet or water tank is installed higher than control valve, or parallel interlock system with multi-outlets, a liquid level controller must be installed in the brine tank. If not, the water outlet or source tank will flow backwards into brine tank during backwashes.*
-  *If making a soldered copper installation, all sweat soldering should be done before connecting pipes to the valve. Torch heat will damage plastic parts.*
-  *When turning threaded pipe fittings onto plastic fitting, take precaution not to cross thread or over tighten.*

Control Valve Installation

1. As Figure 5-1 shows; insert a 32mm riser pipe with bottom basket into the center of the mineral tank. If pipe is higher than the top of the pressure tank, mark it, remove from tank, and cut. Take care to keep foreign material out of pressure tank.



*The length of riser pipe should be below tank flange. The distance from the top of the tank to the top of the pipe should be between **3/16"** and **1"**. The edges of the pipe should not be sharp to avoid damage to the seal inside the RevV4 valve.*

2. If mineral tank was not purchased as part of a complete system from Hanksraft Runxin be sure to plug the riser pipe prior to filling with media. Media quantity is relative to desired capacity and tank size. See Product Sizing Chart on Page 13.
3. Install Valve Base O-ring around the neck of the valve.
4. Lubricate the center hub O-ring of the RevV4 valve.
5. Install the top basket with a twist and lock action to center hub of the RevV4 valve.
6. Place RevV4 valve onto tank with the distributor pipe inserted down the middle of the top basket. Rotate clockwise to secure onto the tank.



Do not overtighten! Overtightening may cause the valve to crack and void the warranty.

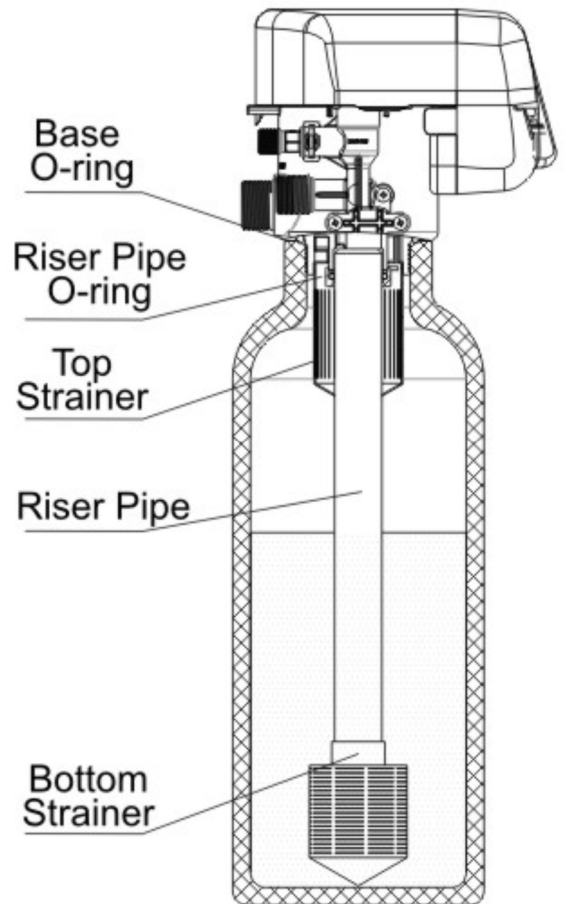

Figure 5-1

System Sizing Chart

Tank Size	Resin Volume cu. ft.	Total System Grains	Salt Setting	Injector Part No.	Color	DLFC	Part No.	Color	BLFC	Part No.	Color
9x48	0.9375	16,577	Low	6302	Pink	2.02	8468060	White	0.3	8468056	White
9x48	0.9375	21,746	Standard	6302	Pink	2.02	8468060	White	0.3	8468056	White
9x48	0.9375	26,488	High	6302	Pink	2.02	8468060	White	0.3	8468056	White
9x48	1	17,682	Low	6302	Pink	2.02	8468060	White	0.3	8468056	White
9x48	1	23,196	Standard	6302	Pink	2.02	8468060	White	0.3	8468056	White
9x48	1	28,254	High	6302	Pink	2.02	8468060	White	0.3	8468056	White
10x44	1.25	22,102	Low	6302	Pink	2.86	8468061	Black	0.39	8468052	Brown
10x44	1.25	28,995	Standard	6302	Pink	2.86	8468061	Black	0.39	8468052	Brown
10x44	1.25	35,317	High	6302	Pink	2.86	8468061	Black	0.39	8468052	Brown
9x48	1.3	23,163	Low	6302	Pink	2.86	8468061	Black	0.39	8468052	Brown
9x48	1.3	30,387	Standard	6302	Pink	2.86	8468061	Black	0.39	8468052	Brown
9x48	1.3	37,013	High	6302	Pink	2.86	8468061	Black	0.39	8468052	Brown
10x54	1.5	26,523	Low	6302	Pink	2.86	8468061	Black	0.39	8468052	Brown
10x54	1.5	34,794	Standard	6302	Pink	2.86	8468061	Black	0.39	8468052	Brown
10x54	1.5	42,381	High	6302	Pink	2.86	8468061	Black	0.39	8468052	Brown
10x54	1.55	27,584	Low	6302	Pink	2.86	8468061	Black	0.39	8468052	Brown
10x54	1.55	36,186	Standard	6302	Pink	2.86	8468061	Black	0.39	8468052	Brown
10x54	1.55	44,076	High	6302	Pink	2.86	8468061	Black	0.39	8468052	Brown
12x52	2	35,364	Low	6303	Yellow	4.22	8468045	Blue	0.83	8468053	Pink
12x52	2	46,392	Standard	6303	Yellow	4.22	8468045	Blue	0.83	8468053	Pink
12x52	2	56,508	High	6303	Yellow	4.22	8468045	Blue	0.83	8468053	Pink

Control Valve Configuration (refer to chart on Page 13 for specific recommendations)

Drain Line Flow Control (DLFC) Button Installation

- If you wish to change the DLFC button, unscrew drain barb collar and remove drain barb.
- Remove current DLFC button and replace with desired DLFC button.
- Replace drain barb and tighten down drain barb collar.

Brine Line Flow Control (BLFC) Button Installation

- If you wish to change the BLFC button, remove brine connector clip and then brine connector from valve.
- Remove current BLFC button and replace with desired BLFC button.
- Replace brine connector to valve and insert brine connector clip.

Injector Throat and Nozzle Installation

- If you wish to change the injector, unscrew the two screws from the injector body and remove the cover.
- Unscrew, in a counter-clockwise direction, remove the nozzle and throat.
- Replace with desired nozzle and throat. Tighten in a clockwise direction until seated.
- Take care not to over tighten or strip the parts.

6. Bypasses

Ceramic Bypass – 41206 / 41207



Before attaching the bypass to the valve, verify the meter is installed into the outlet side of the bypass with the impeller facing in.

- As Figure 5-2 shows; install the seals into the animated connector.
- Attach animated connectors to the inlet/outlet and grease the O-rings.
- Attach the bypass valve and insert the clips.
- Meter cable is installed into cable port on outlet side during system start-up. See Pages 38-39.

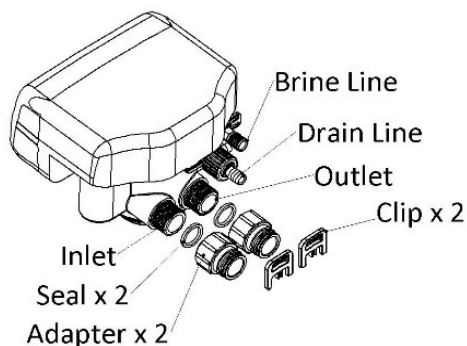
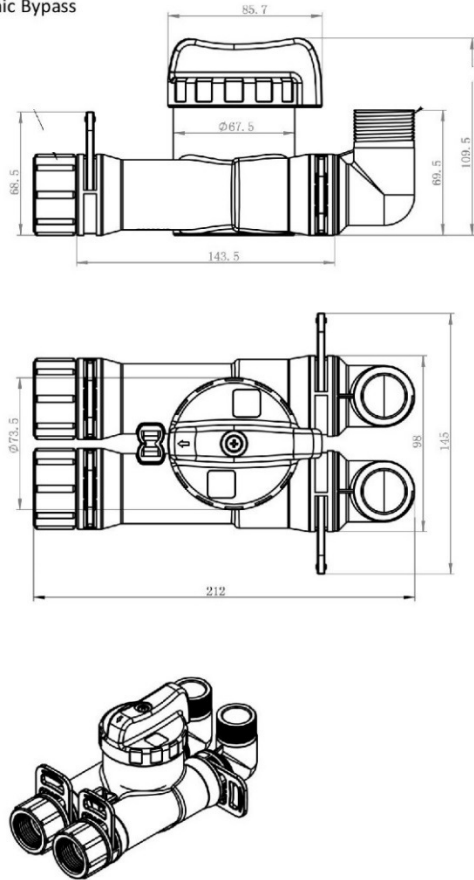

Figure 5-2

Ceramic Bypasses

Hankscraft Part Number 41207
Large Ceramic Bypass



Hankscraft Part Number 41206
Small Ceramic Bypass

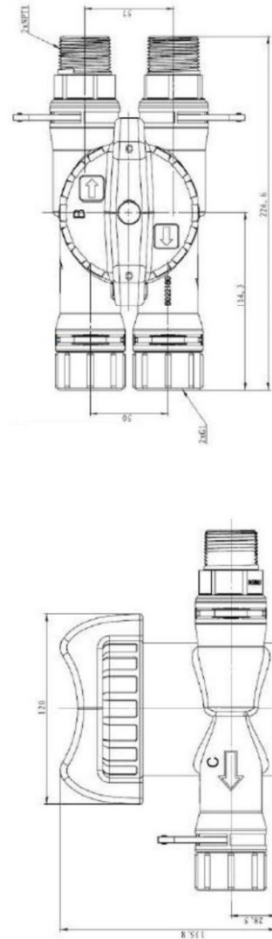

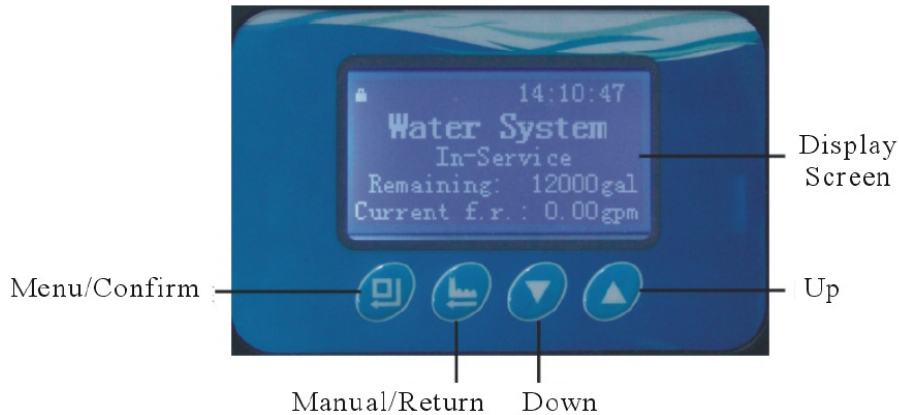

7. Programming: Display and Instructions



Manual / Delayed Regeneration



1. Pressing  at any time results in an immediate manual regeneration.
2. Pressing and holding  for 3 seconds, when system is locked, results in a delayed regeneration at the preselected time.





One Button to Change the Current Time



Pressing and holding the  button for 3 seconds, when system is locked, allows the current time of day to be adjusted.

Unlocking the Keypad



The  icon indicates the buttons are locked within 5 minutes of idle use. To unlock press and hold  and  for 3 seconds until the  icon is off.

Enter Key



Press  button to enter the basic programming mode, modify highlighted options, and return to the main menu.



Manual Regen/Esc. Key



Press  at any phase during manual regeneration to advance to the next phase or press during programming to exit to the home screen without modifying the current highlighted option.











Up and Down Arrows



 and  buttons are used to scroll through the various basic programming options as well as adjust values.







Basic Programming

Allows you to adjust the time values for each phase. To enter basic programming, follow the directions below.

1. When the  icon is on, press and hold both  and  for 3 seconds to unlock the keypad.
2. Press  to enter the main menu; press  or  to highlight each option.
3. Press  to enter highlighted option.
4. Press  or  to adjust the value.
5. Press  to accept changes.
6. Press  to exit back to service status.









Advanced Programming

Allows you to set the Regen Cycle and Regen Mode that will work best for your customer; as well as adjust or set each phase time. To enter advanced programming, follow the directions below.

1. Plug in the RevV4. Immediately press    in sequence to enter into the advanced setting.
2. Press  or  to select the menu item to be changed.
3. Press  to return to the previous menu.



If valve locks while programming, unplug power supply and repeat step above.

4. Press  to enter the main menu; press  or  to highlight each option.
5. Press  to enter highlighted option.
6. Press  or  to adjust the value.
7. Press  to accept changes.
8. Press  to advance to service status.



Programming: Mode A-01

Parameter	Unit	Default	Description
Review Company Info			Displays current programmed company information.
Language *		English	
Set Company Info *			Set company information for display. Three lines available for input.
Set Time of Day	24-hr. Clock		Set current time of day. 24-hour clock format.
Set Date			Set current month, day, and year. XX/XX/20XX
Set Program Type * Interlock / Alternate Interlock		Interlock	Used as a stand-alone installation and twin demand in conjunction with No Hard Water version of the RevV4.
Set Regen Cycles *	1, 2, 3, 4	2	Recommended setting to Sequence 2. See Pages 7-8. Service → Backwash → Brine & Slow Rinse → Back Wash → Fast Rinse → Brine Refill.
Set Clear Data *	Close/Open	Close	Skip during initial set-up. Clears all stored memory and restores default settings. Close = Data saved Open = Reset data
Set Regen Mode: A-01-A-07 *		A-03	Change to A-01 Meter Delayed.
Set Capacity	Grains	2100	To figure capacity, take the total resin volume multiplied by .75. Divide by grains hardness of water supply. Ex: 1 Cu/Ft =32,000 x .75 at 15 grains hardness. $(32,000 \times .75) \div 15=1,600$ gal. Enter that value here.
Set Regen Time	24-hr. Clock	02:00	The time of day the system will regenerate when it reaches system capacity.
Set Backwash Time	Min.	0	Set to 0 (zero) when using Sequence 2 as a softener install.
Set B.S.R. Time	Min.	60	Brine Slow Rinse Stage of Regeneration.
Set Secondary B.W.T. (Backwash Time)	Min.	10	
Set Fast Rinse Time	Min.	10	
Set B.R. Time (Brine Refill)	Min:Sec	10:00	Refill time is calculated based on total resin volume. Note: 1 gal. water dissolves 3 lbs. of salt. See note below for refill time.
Max Days for Regeneration	Days	30	A regeneration is forced every 30 days if water capacity is not reached.
Signal Output Mode b-01 (02) *		b-01	Used for external device. b-01. Disregard for standard installation.
Set Service Alarm *	Days	730	Alarm rings to prompt a service call. Occurs at the number of days set at 8pm for 2 minutes. Display changes to prompt the homeowner to call their dealer.
Daily Usage Log	Gal.		Shows the gallons used each day for the last 7 days.
Daily Peak Usage	Gal.		Shows the highest gallon usage day for the last 7 days.
Weekly Usage Log	Gal.		Shows the gallons used each week for the last 52 weeks.
Weekly Peak Usage	Gal.		Shows the highest gallon usage week for the last 52 weeks.
Monthly Usage Log	Gal.		Shows the gallons used each month for the last 12 months.
Monthly Peak Usage	Gal.		Shows the highest gallon usage month for the last 12 months.
Review Regen Times			Displays the number of times the valve has regenerated independently.
Review Software Ver.			Shows current software version of RevV4 valve.

Above parameters are located in standard program settings menu.

(*) Denotes parameters located in advanced program settings menu.

Programming: Modes A-02

Parameter	Unit	Default	Description
Review Company Info			Displays current programmed company information.
Language *		English	
Set Company Info *			Set company information for display. Three lines available for input.
Set Time of Day	24-hr. Clock		Set current time of day. 24-hour clock format.
Set Date			Set current month, day, and year. XX/XX/20XX
Set Program Type * Interlock / Alternate Interlock		Interlock	Used as a stand-alone installation and twin demand in conjunction with No Hard Water version of the RevV4.
Set Regen Cycles *	1, 2, 3, 4	2	Recommended setting to Sequence 2. See Pages 7-8. Service → Backwash → Brine & Slow Rinse → Back Wash → Fast Rinse → Brine Refill.
Set Clear Data *	Close/Open	Close	Skip during initial set-up. Clears all stored memory and restores default settings. Close = Data saved Open = Reset data
Set Regen Mode: A-01-A-07 *		A-03	Change to A-02 Meter Immediate.
Set Capacity	Grains	2100	To figure capacity, take the total resin volume multiplied by .75. Divide by grains hardness of water supply. Ex: 1 Cu/Ft =32,000 x .75 at 15 grains hardness. (32,000 x .75) ÷ 15=1,600 gal. Enter that value here.
Set Backwash Time	Min.	0	Set to 0 (zero) when using Sequence 2 as a softener install.
Set B.S.R. Time	Min.	60	Brine Slow Rinse Stage of Regeneration.
Set Secondary B.W.T. (Backwash Time)	Min.	10	
Set Fast Rinse Time	Min.	10	
Set B.R. Time (Brine Refill)	Min:Sec	10:00	Refill time is calculated based on total resin volume. Note: 1 gal. water dissolves 3 lbs. of salt. See note below for refill time.
Max Days for Regeneration	Days	30	A regeneration is forced every 30 days if no water has been used.
Signal Output Mode b-01 (02) *		b-01	Used for external device. b-01. Disregard for standard installation.
Set Service Alarm *	Days	730	Alarm rings to prompt a service call. Occurs at the number of days set at 8pm for 2 minutes. Display changes to prompt the homeowner to call their dealer.
Daily Usage Log	Gal.		Shows the gallons used each day for the last 7 days.
Daily Peak Usage	Gal.		Shows the highest gallon usage day for the last 7 days.
Weekly Usage Log	Gal.		Shows the gallons used each week for the last 52 weeks.
Weekly Peak Usage	Gal.		Shows the highest gallon usage week for the last 52 weeks.
Monthly Usage Log	Gal.		Shows the gallons used each month for the last 12 months.
Monthly Peak Usage	Gal.		Shows the highest gallon usage month for the last 12 months.
Review Regen Times			Displays the number of times the valve has regenerated independently.
Review Software Ver.			Shows current software version of RevV4 valve.

Above parameters are located in standard program settings menu.

(*) Denotes parameters located in advanced program settings menu.



Programming: Modes A-03

Parameter	Unit	Default	Description
Review Company Info			Displays current programmed company information.
Language *		English	
Set Company Info *			Set company information for display. Three lines available for input
Set Time of Day	24-hr. Clock		Set current time of day. 24-hour clock format.
Set Date			Set current month, day, and year. XX/XX/20XX
Set Program Type *		Interlock	Used as a stand-alone installation and twin demand in conjunction with No Hard Water version of the RevV4.
Interlock / Alternate Interlock			
Set Regen Cycles *	1, 2, 3 ,4	2	Recommended setting to Sequence 2. See Pages 7-8. Service → Backwash → Brine & Slow Rinse → Back Wash → Fast Rinse → Brine Refill.
Set Clear Data *	Close/Open	Close	Skip during initial set-up. Clears all stored memory and restores default settings. Close = Data saved Open = Reset data
Set Regen Mode: A-01-A-07 *		A-03	A-03 Intelligent Meter Delayed.
Set Total Capacity	Grains	32000	Total Volume of Media in System. 1 cubic foot (32,000 grains) is default.
Set Water Hardness	Grains per Gallon (gpg)	10	Total water hardness of incoming water supply. Amount varies per location. It is highly recommended to have tested for correct function/performance.
Set Number of People		4	The number of people in the residence
Set Regen Time	24-hr. Clock	02:00	The time of day the system will regenerate when it reaches system capacity.
Set Backwash Time	Min.	0	Set to 0 (zero) when using Sequence 2 as a softener install.
Set B.S.R. Time	Min.	60	Brine Slow Rinse Stage of Regeneration.
Set Secondary B.W.T. (Backwash Time)	Min.	10	
Set Fast Rinse Time	Min.	10	
Set B.R. Time (Brine Refill)	Min:Sec	10:00	Refill time is calculated based on total resin volume. Note: 1 gal. water dissolves 3 lbs. of salt. See note below for refill time.
Max Days for Regeneration	Days	30	A regeneration is forced every 30 days if no water has been used.
Signal Output Mode b-01 (02) *		b-01	Used for external device. b-01. Disregard for standard installation.
Set Service Alarm *	Days	730	Alarm rings to prompt a service call. Occurs at the number of days set at 8pm for 2 minutes. Display changes to prompt the homeowner to call their dealer.
Daily Usage Log	Gal.		Shows the gallons used each day for the last 7 days.
Daily Peak Usage	Gal.		Shows the highest gallon usage day for the last 7 days.
Weekly Usage Log	Gal.		Shows the gallons used each week for the last 52 weeks.
Weekly Peak Usage	Gal.		Shows the highest gallon usage week for the last 52 weeks.
Monthly Usage Log	Gal.		Shows the gallons used each month for the last 12 months.
Monthly Peak Usage	Gal.		Shows the highest gallon usage month for the last 12 months.
Review Regen Times			Displays the number of times the valve has regenerated independently.
Review Software Ver.			Shows current software version of RevV4 valve.

Above parameters are located in standard program settings menu.

(*) Denotes parameters located in advanced program settings menu.

Programming: Modes A-04

Parameter	Unit	Default	Description
Review Company Info			Displays current programmed company information.
Language *		English	
Set Company Info *			Set company information for display. Three lines available for input
Set Time of Day	24-hr. Clock		Set current time of day. 24-hour clock format.
Set Date			Set current month, day, and year. XX/XX/20XX
Set Program Type * Interlock / Alternate Interlock		Interlock	Used as a stand-alone installation and twin demand in conjunction with No Hard Water version of the RevV4.
Set Regen Cycles *	1, 2, 3, 4	2	Recommended setting to Sequence 2. See Page 7-8. Service → Backwash → Brine & Slow Rinse → Back Wash → Fast Rinse → Brine Refill.
Set Clear Data *	Close/Open	Close	Skip during initial set-up. Clears all stored memory and restores default settings. Close = Data saved Open = Reset data
Set Regen Mode: A-01-A-07 *		A-03	Change to A-04 Intelligent Meter Immediate.
Set Total Capacity	Grains	32000	Total Volume of Media in System. 1 cubic foot (32,000 grains) is default.
Set Water Hardness	Grains per Gallon (gpg)	10	Total water hardness of incoming water supply. Amount varies per location. It is highly recommended to have tested for correct function/performance.
Set Backwash Time	Min.	0	Set to 0 (zero) when using Sequence 2 as a softener install.
Set B.S.R. Time	Min.	60	Brine Slow Rinse Stage of Regeneration.
Set Secondary B.W.T. (Backwash Time)	Min.	10	
Set Fast Rinse Time	Min.	10	
Set B.R. Time (Brine Refill)	Min:Sec	10:00	Refill time is calculated based on total resin volume. Note: 1 gal. water dissolves 3 lbs. of salt. See note below for refill time.
Max Days for Regeneration	Days	30	A regeneration is forced every 30 days if no water has been used.
Signal Output Mode b-01 (02) *		b-01	Used for external device. b-01. Disregard for standard installation.
Set Service Alarm *	Days	730	Alarm rings to prompt a service call. Occurs at the number of days set at 8pm for 2 minutes. Display changes to prompt the homeowner to call their dealer.
Daily Usage Log	Gal		Shows the gallons used each day for the last 7 days.
Daily Peak Usage	Gal		Shows the highest gallon usage day for the last 7 days.
Weekly Usage Log	Gal		Shows the gallons used each week for the last 52 weeks.
Weekly Peak Usage	Gal		Shows the highest gallon usage week for the last 52 weeks.
Monthly Usage Log	Gal		Shows the gallons used each month for the last 12 months.
Monthly Peak Usage	Gal		Shows the highest gallon usage month for the last 12 months.
Review Regen Times			Displays the number of times the valve has regenerated independently.
Review Software Ver.			Shows current software version of RevV4 valve.

Above parameters are located in standard program settings menu.

(*) Denotes parameters located in advanced program settings menu.



Programming: Modes A-05

Parameter	Unit	Default	Description
Review Company Info			Displays current programmed company information.
Language *		English	
Set Company Info *			Set company information for display. Three lines available for input
Set Time of Day	24-hr. Clock		Set current time of day. 24 hour clock format.
Set Date			Set current month, day, and year. XX/XX/20XX
Set Program Type * Interlock / Alternate Interlock		Interlock	Used as a stand-alone installation and twin demand in conjunction with No Hard Water version of the RevV4.
Set Regen Cycles *	1, 2, 3, 4	2	Recommended setting to Sequence 2. See Pages 7-8. Service → Backwash → Brine & Slow Rinse → Back Wash → Fast Rinse → Brine Refill.
Set Clear Data *	Close/Open	Close	Skip during initial set-up. Clears all stored memory and restores default settings. Close = Data saved Open = Reset data
Set Regen Mode: A-01-A-07 *		A-03	Change to A-05 Remaining Compare.
Set Capacity	Grains	2100	To figure capacity, take the total resin volume multiplied by .75. Divide by grains hardness of water supply. Ex: 1 Cu/Ft =32,000 x .75 at 15 grains hardness. $(32,000 \times .75) \div 15=1,600$ gal. Enter that value here.
Set Regen Time	24-hr. Clock	02:00	The time of day the system will regenerate when it reaches system capacity.
Set Backwash Time	Min.	0	Set to 0 (zero) when using Sequence 2 as a softener install.
Set B.S.R. Time	Min.	60	Brine Slow Rinse Stage of Regeneration.
Set Secondary B.W.T. (Backwash Time)	Min.	10	
Set Fast Rinse Time	Min.	10	
Set B.R. Time (Brine Refill)	Min:Sec	10:00	Refill time is calculated based on total resin volume. Note: 1 gal. water dissolves 3 lbs. of salt. See note below for refill time.
Max Days for Regeneration	Days	30	A regeneration is forced every 30 days if no water has been used.
Signal Output Mode b-01 (02) *		b-01	Used for external device. b-01. Disregard for standard installation.
Set Service Alarm *	Days	730	Alarm rings to prompt a service call. Occurs at the number of days set at 8pm for 2 minutes. Display changes to prompt the homeowner to call their dealer.
Daily Usage Log	Gal.		Shows the gallons used each day for the last 7 days.
Daily Peak Usage	Gal.		Shows the highest gallon usage day for the last 7 days.
Weekly Usage Log	Gal.		Shows the gallons used each week for the last 52 weeks.
Weekly Peak Usage	Gal.		Shows the highest gallon usage week for the last 52 weeks.
Monthly Usage Log	Gal.		Shows the gallons used each month for the last 12 months.
Monthly Peak Usage	Gal.		Shows the highest gallon usage month for the last 12 months.
Review Regen Times			Displays the number of times the valve has regenerated independently.
Review Software Ver.			Shows current software version of RevV4 valve.

Above parameters are located in standard program settings menu.

(*) Denotes parameters located in advanced program settings menu.

Programming: Modes A-06

Parameter	Unit	Default	Description
Review Company Info			Displays current programmed company information.
Language *		English	
Set Company Info *			Set company information for display. Three lines available for input
Set Time of Day	24-hr. Clock		Set current time of day. 24-hour clock format.
Set Date			Set current month, day, and year. XX/XX/20XX
Set Program Type * Interlock / Alternate Interlock		Interlock	Used as a stand-alone installation and twin demand in conjunction with No Hard Water version of the RevV4.
Set Regen Cycles *	1, 2, 3, 4	2	Recommended setting to Sequence 2. See Pages 7-8. Service → Backwash → Brine & Slow Rinse → Back Wash → Fast Rinse → Brine Refill.
Set Clear Data *	Close/Open	Close	Skip during initial set-up. Clears all stored memory and restores default settings. Close = Data saved Open = Reset data
Set Regen Mode: A-01-A-07 *		A-03	Change to A-06 Timer.
Set Service Days	Days	3	Number of days between regenerations.
Set Regen Time	24-hr. Clock	02:00	The time of day the system will regenerate when it reaches system capacity.
Set Backwash Time	Min.	0	Set to 0 (zero) when using Sequence 2 as a softener install.
Set B.S.R. Time	Min.	60	Brine Slow Rinse Stage of Regeneration.
Set Secondary B.W.T. (Backwash Time)	Min.	10	
Set Fast Rinse Time	Min.	10	
Set B.R. Time (Brine Refill)	Min:Sec	10:00	Refill time is calculated based on total resin volume. Note: 1 gal. water dissolves 3 lbs. of salt. See note below for refill time.
Signal Output Mode b-01 (02) *		b-01	Used for external device. b-01. Disregard for standard installation.
Set Service Alarm *	Days	730	Alarm rings to prompt a service call. Occurs at the number of days set at 8pm for 2 minutes. Display changes to prompt the homeowner to call their dealer.
Review Regen Times			Displays the number of times the valve has regenerated independently.
Review Software Ver.			Shows current software version of RevV4 valve.

Above parameters are located in standard program settings menu.

(*) Denotes parameters located in advanced program settings menu.



Programming: Modes A-07

Parameter	Unit	Default	Description
Review Company Info			Displays current programmed company information.
Language *		English	
Set Company Info *			Set company information for display. Three lines available for input
Set Time of Day	24-hr. Clock		Set current time of day. 24-hour clock format.
Set Date			Set current month, day, and year. XX/XX/20XX
Set Program Type * Interlock / Alternate Interlock		Interlock	Used as a stand-alone installation and twin demand in conjunction with No Hard Water version of the RevV4.
Set Clear Data *	Close/Open	Close	Skip during initial set-up. Clears all stored memory and restores default settings. Close = Data saved Open = Reset data
Set Regen Mode: A-01-A-07 *		A-03	Change to A-07 Filter Meter.
Set Capacity	Grains	2100	To figure capacity, take the total resin volume multiplied by .75. Divide by grains hardness of water supply. Ex: 1 Cu/Ft =32,000 x .75 at 15 grains hardness. $(32,000 \times .75) \div 15=1,600$ gal. Enter that value here.
Set Rinse Frequency	F	F-00	Set the number of additional rinses (backwashes) preferred.
Set Regen Time	24-hr. Clock	02:00	The time of day the system will regenerate when it reaches system capacity.
Set Backwash Time	Min.	0	Recommend 10 minute backwash cycle.
Set Fast Rinse Time	Min.	10	
Max Days for Regeneration	Days	30	A regeneration is forced every 30 days if no water has been used.
Signal Output Mode b-01 (02) *		b-01	Used for external device. b-01. Disregard for standard installation.
Set Service Alarm *	Days	730	Alarm rings to prompt a service call. Occurs at the number of days set at 8pm for 2 minutes. Display changes to prompt the homeowner to call their dealer.
Daily Usage Log	Gal.		Shows the gallons used each day for the last 7 days.
Daily Peak Usage	Gal.		Shows the highest gallon usage day for the last 7 days.
Weekly Usage Log	Gal.		Shows the gallons used each week for the last 52 weeks.
Weekly Peak Usage	Gal.		Shows the highest gallon usage week for the last 52 weeks.
Monthly Usage Log	Gal.		Shows the gallons used each month for the last 12 months.
Monthly Peak Usage	Gal.		Shows the highest gallon usage month for the last 12 months.
Review Regen Times			Displays the number of times the valve has regenerated independently.
Review Software Ver.			Shows current software version of RevV4 valve.

Above parameters are located in standard program settings menu. (*) Denotes parameters located in advanced program settings menu.



Backwash time and rinse frequency is dependent on media and application.

8. PCB Functions and Connections

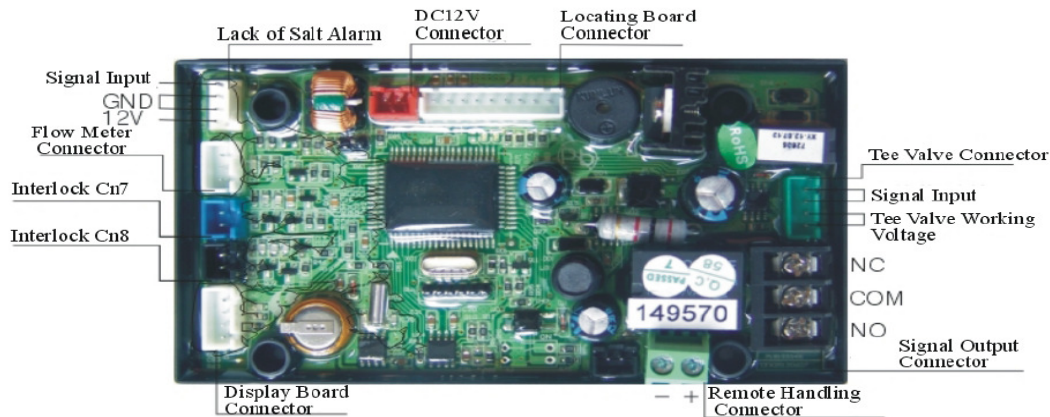

Overview

Function	Application	Explanation
Signal Output Connector b-01	Outlet solenoid valve	Optional to prevent water flow from outlet or controlling a liquid level holding tank.
	Inlet pump	Increase pressure for regeneration or backwash. Use a liquid level controller to control inlet pump.
Signal Output Connector b-02	Inlet solenoid valve or inlet pump	When inlet pressure is high, a solenoid shut off can be used to protect the valve during regeneration.
3-Way Ball Valve Drive	Motorized 3-way ball valve	With alternating interlock the ball valve actuates to supply water to one valve while another is on standby.
Interlock Connector	Used for a series of valves	Only one valve in a series can regenerate at a time.
Remote Handling Connector	Accepts input for regeneration from external source	A PLC or computer is allowed to dictate regeneration functions for the valve.

Signal Output

The two types of output modes are b-01 and b-02. The output signal connector is designed to drive several different types of electrical devices. (Refer to Figures 8-1 to 8-7)

b-01

Switches the signal at the start of a regeneration and shuts off at the end of a regeneration.

b-02

Switches the signal at the intervals shown below and in service. (Regeneration sequence 1 is used in this example)

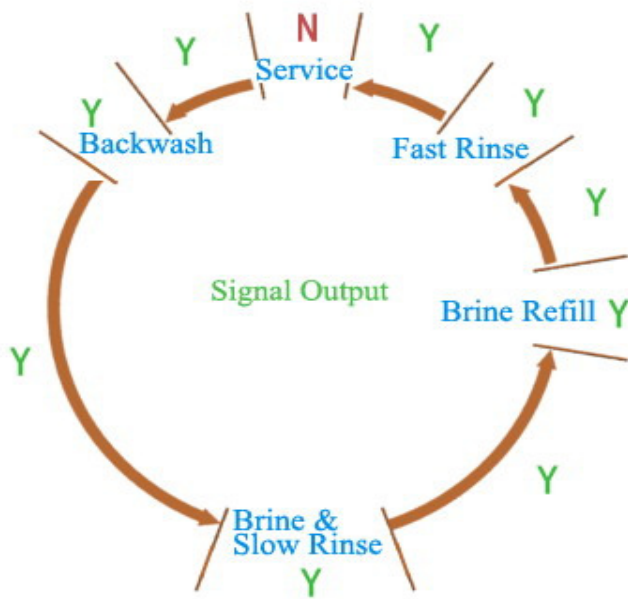

b-01

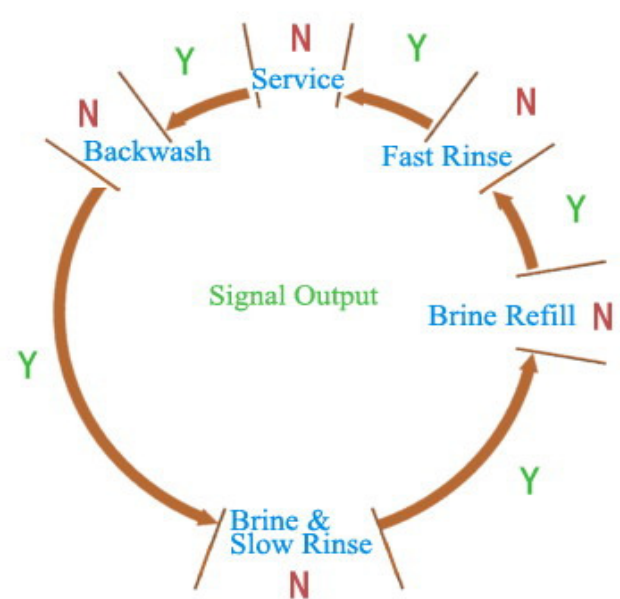

b-02

Signal Output Connector

Solenoid Valve on Outlet (set b-01)

Function: Valve is normally open. When the RevV4 is in backwash there is no signal output. The solenoid valve is closed and no water flows through the RevV4 to the holding tank.

Refer to Figure 8-1 to connect a solenoid valve for the purpose of shutoff during regeneration.

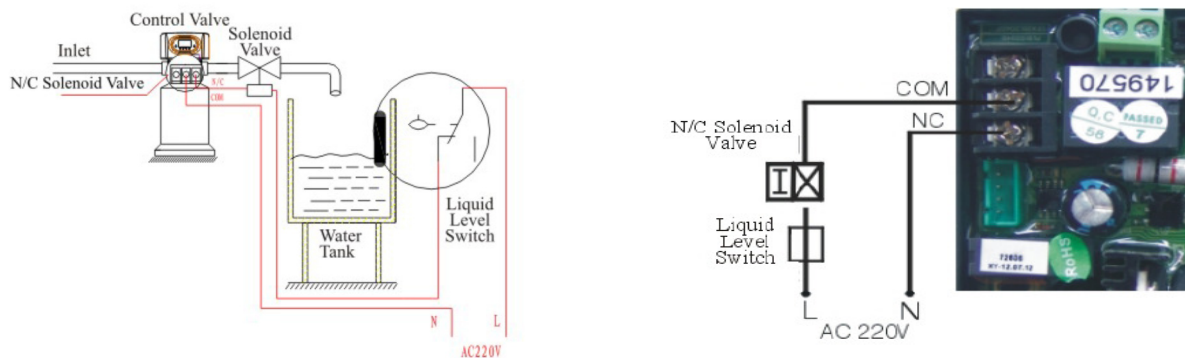

Figure 8-1 Solenoid Valve on Outlet

Solenoid Valve on Inlet (set b-02)

Function: When inlet pressure exceeds 125 psi, install a solenoid valve on the inlet to switch off the flow to the valve during regeneration.

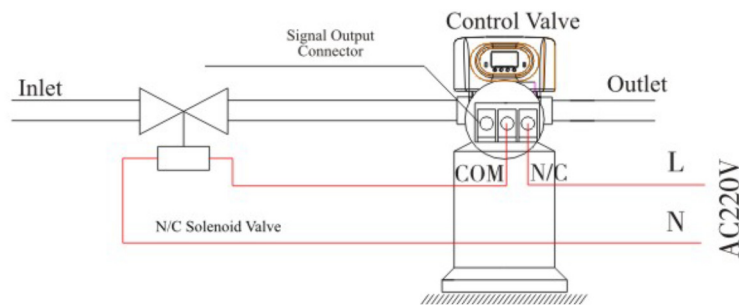

Figure 8-2 Wiring of Solenoid Valve on Inlet

Function: When the RevV4 is in Service, Backwash, Brine & Slow Rinse, Brine Refill and Fast Rinse the solenoid valve is open. When the RevV4 is switching the solenoid valve is closed and no water flows through the RevV4. Also prevents water hammering in high psi applications.



If employing a series of RevV4 valves with a solenoid Figure 8-3 depicts the wiring connections.

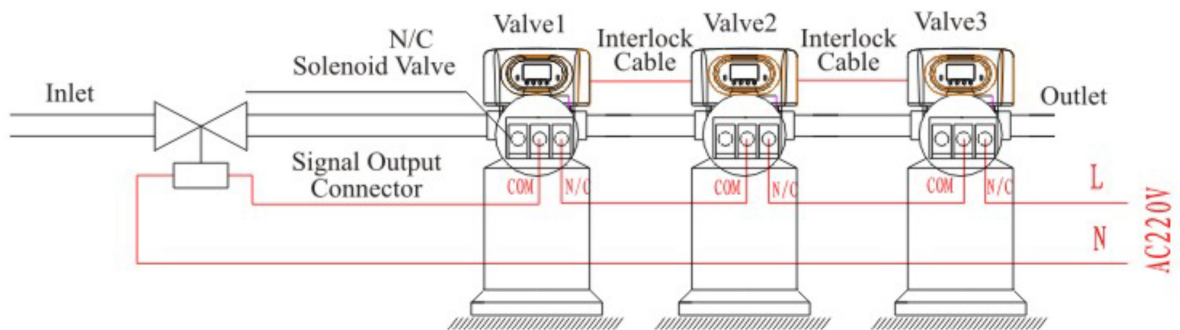

Figure 8-3 Wiring of Solenoid Valve on Inlet

Liquid Level Controller with Inlet Pump (two-phase motor) (set b-01)

Function: For a well system and holding tank, the RevV4 can act as a relay for the booster pump. Refer to Figure 8-4 for wiring.

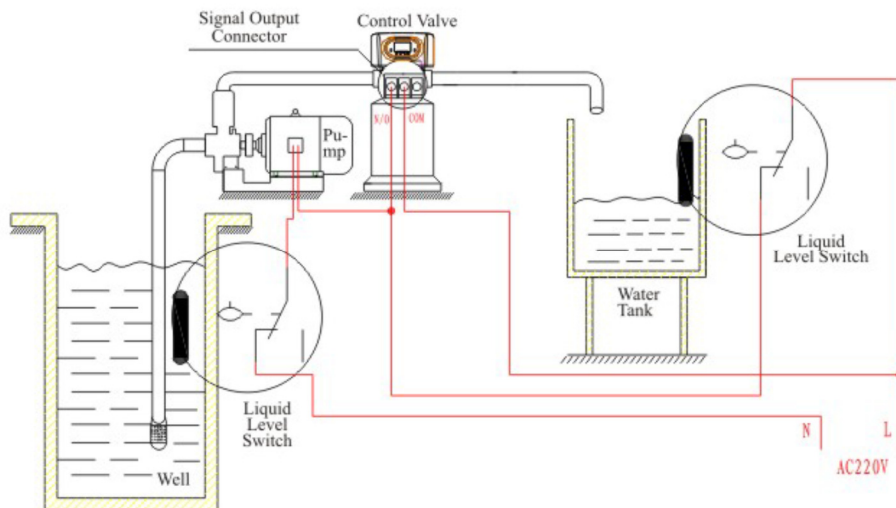

Figure 8-4

Function: When the RevV4 is in service and the water level in the tank is low the pump starts up. If the water tank has enough water the switch for the liquid level controller is closed and the pump turns off. When the RevV4 is in regeneration the inlet always requires water. A safety switch should be installed in the holding tank so the pump does not go dry.

Liquid Level Switch in Water Tank Controls Inlet Pump (three-phase) (set b-01)

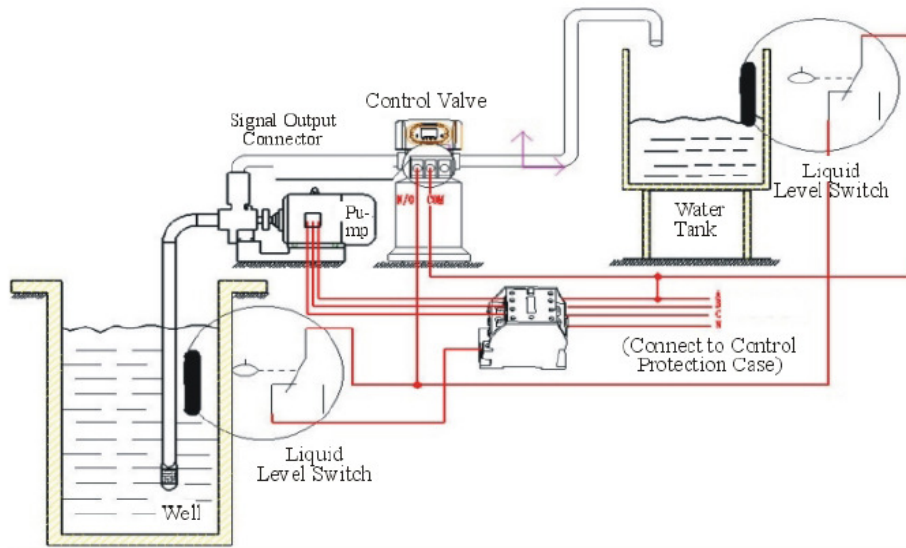

Figure 8-5 Wiring of Liquid Level Switch in the Holding Tank with the Pump on the Inlet.

Inlet Booster Pump (set b-01 or b-02)

Function: If inlet water pressure is less than 20 psi, install a pump on the inlet side of the RevV4; usually set for control mode b-01. When the RevV4 valve is in regeneration, the booster pump is open and active. If the booster pump current is greater than 5A, an external contact is required. Refer to Figure 8-6 and 8-7.

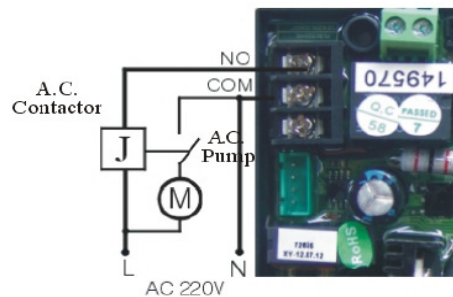
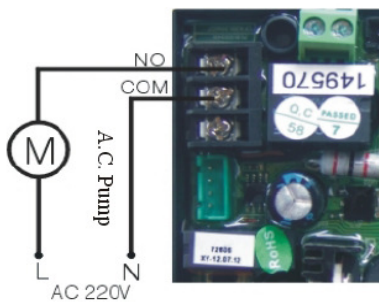

Figure 8-6 Schematic of output to a pump < 5A. Figure 8-7 Schematic of output to a pump > 5A. Incorporates relay.

Interlock

When two valves are connected with the interlock cable and both valves have reached maximum capacity the valve displays “system supply water temporary”. When both valves are set to alternate interlock, then one valve is in service and the other is in standby, the waiting valve screen displays “system wait supplying water”.

Function: With parallel installation only one valve regenerates at a time. Refer to Figure 8-8.

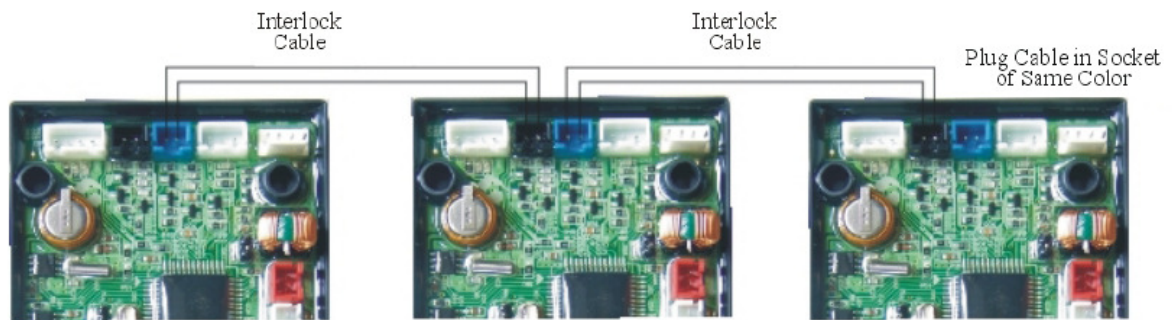

Figure 8-8 Interlocking a Network of Valves.

i Use Interlock cable to connect CN8 to CN7 to the next RevV4 in the series. If one interlock cable is disconnected, the system is divided into two individual systems.

Alternating Interlock

Function: One valve will always be in service. Refer to Figure 8-9.

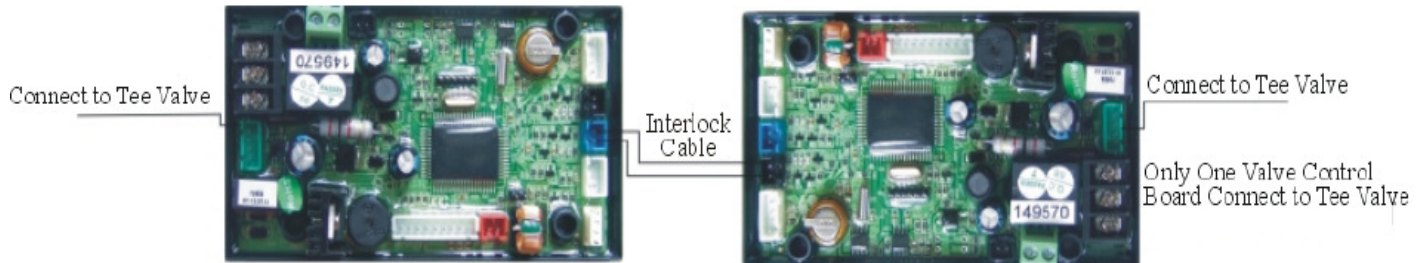

Figure 8-9 Wiring for Alternating Interlock

Remote Handling Connector

Function: Online TDS meter monitor, PLC or computer to control the regeneration schedule. When the controller receives a contact closure from one of the above instruments, regeneration begins. Refer to Figure 8-10.

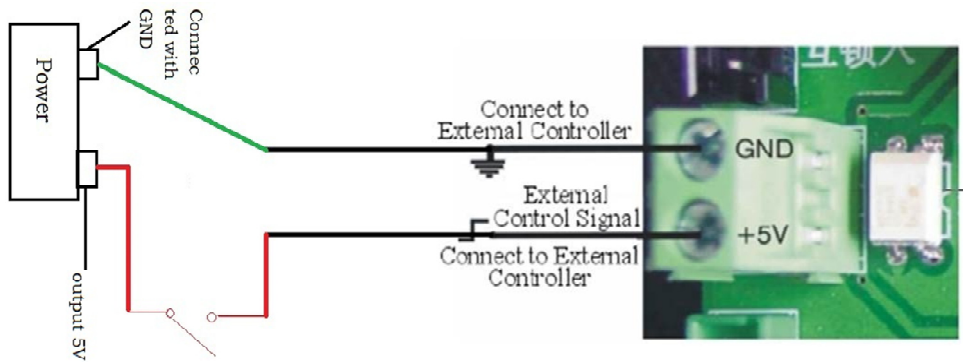

Figure 8-10 Remote Handling Schematic.

Interlock Options

Function: 2 or more valves interlocked connecting in one system. Refer to Figure 8-11 and 8-12.

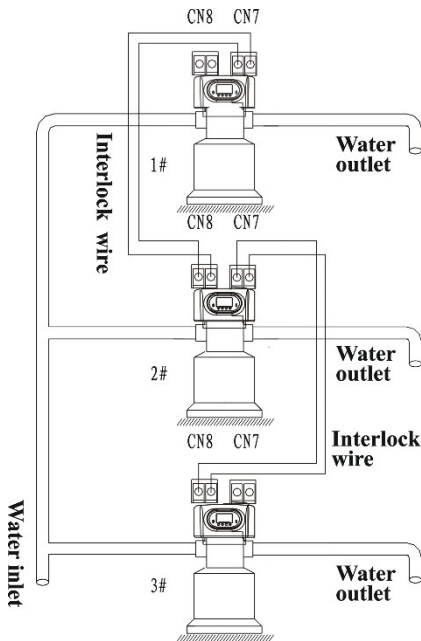

Figure 8-11 All in Service Singular Regeneration.

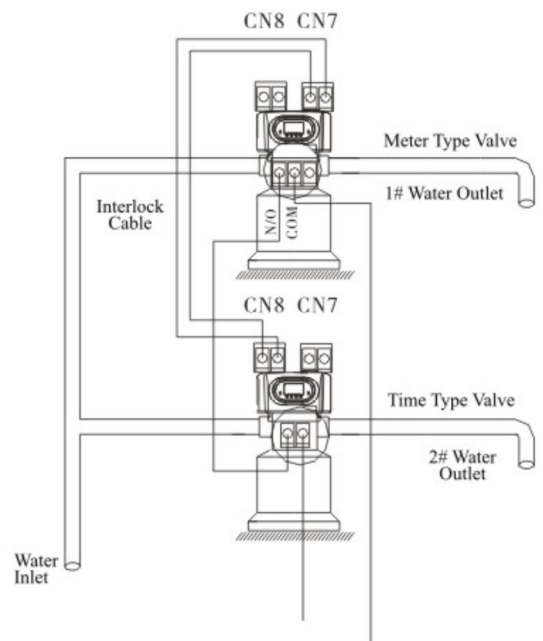

Figure 8-12 Remote Handling Sequentially Set.

Using One Flow Meter with Interlock

Function: Allows for continuous service and simultaneous non overlapping regeneration. This application is for 2 or more RevV4's in a system, all in service, with one flow meter for the entire system. Adjust the Time Clock valve to the maximum days. This avoids a regeneration prior to the metered valve reaching capacity. Connect the signal output connector of the metered valve to the remote handling connector of the Time Clock valve. Refer to Figure 8-12.

9. System Installation

Valve Set-up and Installation - See Page 11-14.

Plumbing Connections

As Figure 9-1 shows; connect inlet pipe, via a 1" NPT female connector, to the inlet connector of bypass. Repeat steps for the outlet pipe.

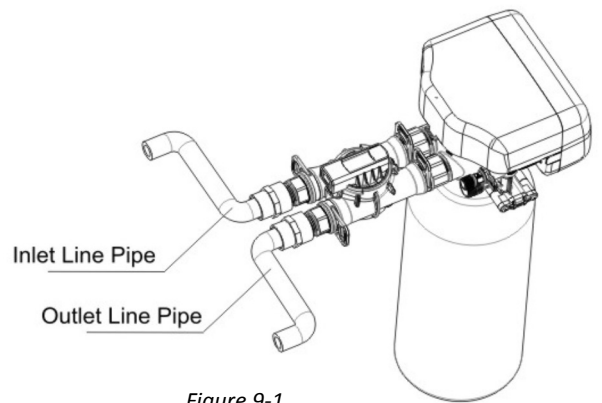

Figure 9-1

Drain Line Installation

As Figure 9-2 shows; insert drain line with an air gap to the floor drain. Valve drain hose not supplied.

CAUTION

An air gap is required between the drain line and the drain (sewer). This avoids a syphon effect and reverse contamination.

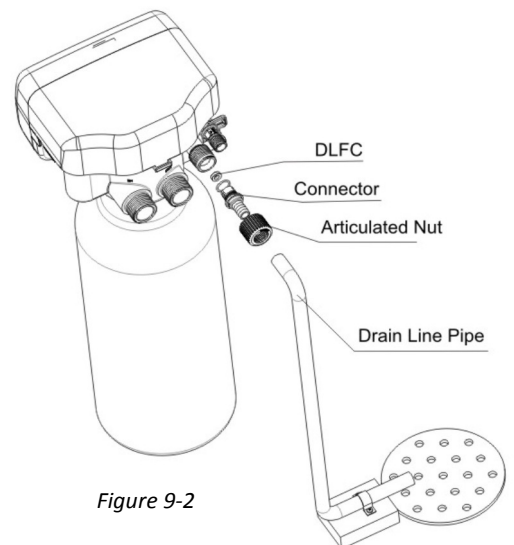

Figure 9-2

Brine Line Connection

1. As Figure 9-3 shows; slide brine nut onto the 3/8" brine tubing.
2. Install the filter screen into the ferrule and insert the ferrule into the end of brine tube.
3. Insert tube into brine connector and tighten brine nut to the brine connector.



Take care to not crimp or plug the brine line or drain line.

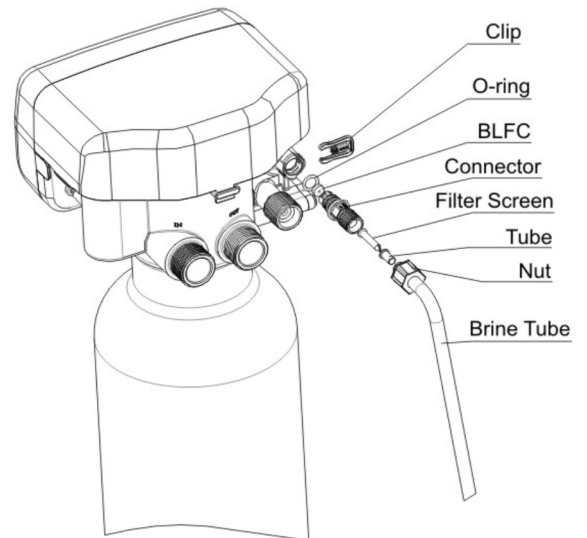

Figure 9-3

Brine Tank Installation

1. Unpack brine tank components
 - Brine tank standoff with nut and washer
 - Overflow elbow with nut and washer
 - Optional quick connect clips
2. Open brine well and remove float. Ensure the inside of the tank and brine well are free of debris.



3. Assemble salt grid (4 feet, 1 base). Feet clip into the bottom of the base.

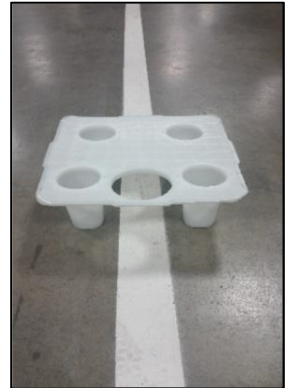

4. Insert assembled salt grid into brine tank by lining up the cut out hole with the drilled holes on the brine tank.



5. Hold float and connected ABS tubing (at the bottom; securing the ABS tubing), turn the black nut counterclockwise while the tubing is secured in place. Set to desired salt setting and retighten float nut.

Tank Size	Letter	Salt Level (See Fig. 4)	Salt Setting
9x48	A	To white tape or above	9 lbs.
10x44	B	Halfway between white/blue tape or above	~ 10.5 lbs.
10x54	C	To blue tape or above	12 lbs.
12x52	D	To green tape or above	15 lbs.
13x54	E	To green tape or above	> 15 lbs.

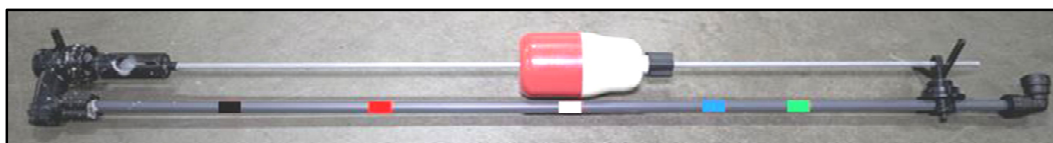

A **B** **C** **D**
E

6. Insert the brine well, making sure the bottom brine well cap is attached. Insert the float assembly by lining up the top cut out holes.



Through testing there have been some instances where the bottom float assembly cap can come off of the tube when force is applied. Therefore we strongly suggest using Gorilla Glue or any equivalent glue to glue the bottom (only) float assembly cap to the tube to prevent this cap from coming off the tube.



7. Install brine tank standoff over the float assembly and insert into top cut out hole. Attach washer on outside of tank and secure unit.



8. Insert brine line into the top cut out hole, through the standoff, and into the quick connect elbow (optional: attach blue clips). Press firmly to make sure brine line is fully inserted into the quick connect.



9. Install overflow elbow fitting with washer on the outside of tank.
Fasten nut on the inside of the tank.

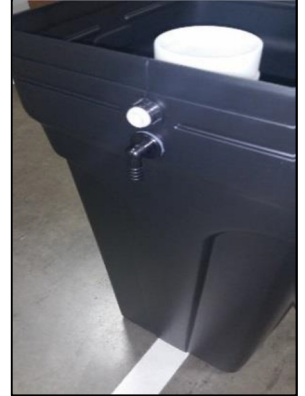

10. Replace brine well lid.



11. Replace brine tank lid.



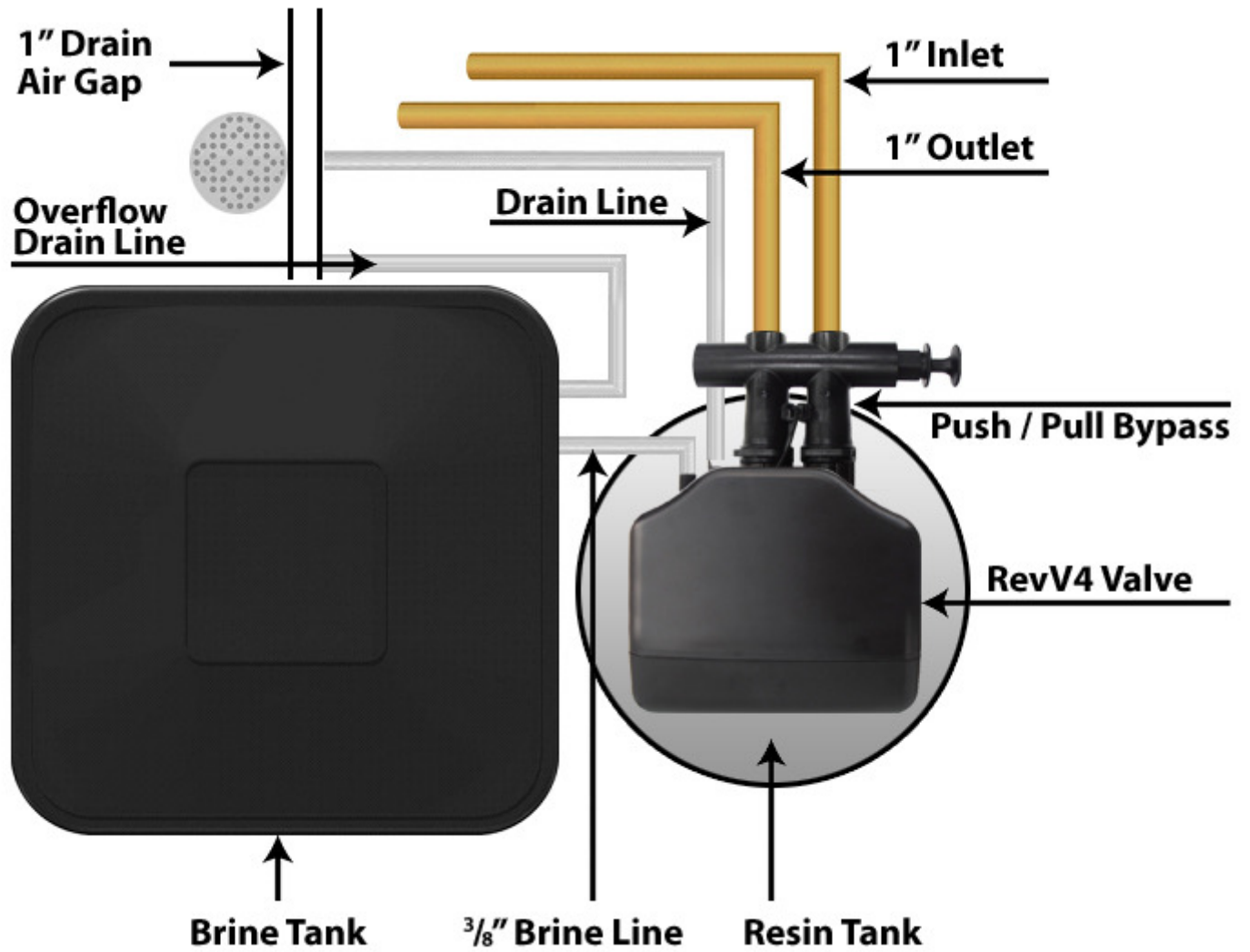

System Installation Chart







System Start-Up

1. Before running the RevV4 for the first time, flush out the water line and bypass. Be sure the bypass is closed.
2. Turn the water source on at the inlet to the house.
3. Disconnect the bypass from the RevV4, if attached to the valve.
4. Remove the meter impeller from the bypass before opening the bypass.
5. Put a container under the bypass; open the bypass to allow water to flow through and remove any foreign material out of the water lines.
6. Close the bypass.
7. Reinstall the meter impeller in the outlet side with the impeller facing in and re-connect the bypass to the valve.
8. Open the bypass.
9. Check for any leaks.
10. Insert meter cable in the outlet side of the bypass or connector; the side the impeller is installed in.
11. Plug in the power cord for the valve.
12. Open a water line and let water flow until water runs clear.
13. Press and hold both  and  buttons simultaneously for 3 seconds to unlock the key pad.
14. Press  to advance through each cycle... backwash, B. S. R. (brine & slow rinse) - *verify the air check valve is closed by listening to be sure no air is being drawn into the system*, secondary backwash, and fast rinse until you reach secondary backwash; this lets air out of the drain line and will take 8-10 minutes to purge the system.



When you press  the screen will display “motor running” as it positions the ceramic disc. Once “motor running” disappears and the next phase is displayed, press  to advance to the next phase.

15. Next to fill the brine tank with water press  to manually advance through the next phase, fast rinse, until you reach B.R. (brine refill).
16. Once you reach B.R. (brine refill) allow this phase to run, do not advance past this phase. This will automatically fill the brine tank with the correct amount of water. This phase will take 10 minutes for a 1 cu/ft. system. After this phase has completed, it will advance to the in-service position.
17. Next add salt into brine tank. (40lb minimum, 120lb maximum)



We recommend using pellet salt, NOT solar salt.

18. Install brine tank cover.
19. Turn a faucet on, away from the installation location, until the water from the plumbing lines has been purged.
20. Softening system is now fully operational.
21. Take a water sample to verify and test for hardness reduction.



Sanitation Procedure

At the start up or after service, the following procedure is recommended to exclude the possibility of microbiological contamination of the system. This procedure relates only to the original description of equipment and options described for this system. Any alterations to the configuration would require evaluation by a trained water professional.

1. Remove the brine tank cover and locate the brine well.
2. Remove the brine well cap.
3. Pour 1/3 cup of unscented bleach into the brine well.
4. Place cap back on brine well and cover back on brine tank.
5. The system must be regenerated. Select an immediate regeneration or a delayed regeneration.

Immediate Regeneration

- a. At the control valve, press ▲ and ▼ and hold for 3 seconds to unlock the valve.
- b. Press ⏸ to start an immediate regeneration.
- c. Allow approximately 2 hours for the valve to complete its regeneration cycle and return to service mode.

Delayed Regeneration

- a. At the control valve, press ⏸ and hold for 3 seconds to set a delayed regeneration that very next morning at the programmed time. (Default setting is 2:00am)

Water Flow Diagrams

Service Position

Raw water enters into the control valve from water inlet A, from the top of valve core and into the tank from top distributor. Then the water moves down through the resin layers, through bottom strainer and up through the riser tube, through the valve core, and flows out of water outlet B.

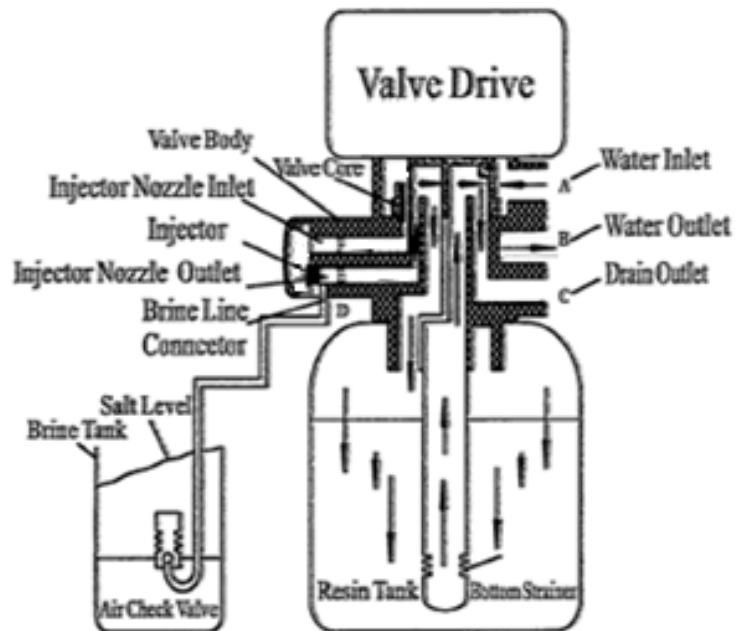

Backwash Position

Set to 0 for standard softeners and skipped. Raw water enters into the control valve from water inlet A, through valve body from the top of valve core, then travels down through the riser tube and up through the resin, into the valve core, and finally flows out from drain outlet C.

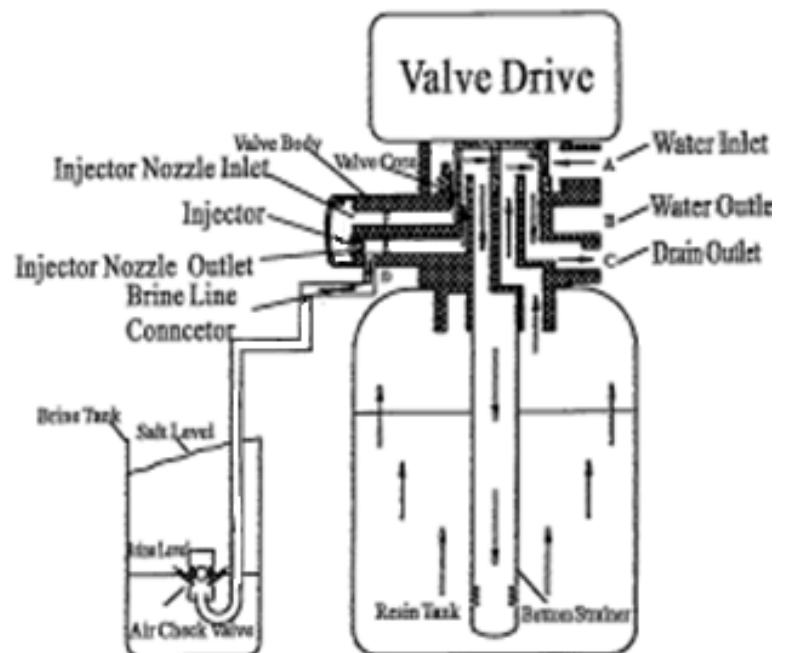

Brine Draw Position

Raw water enters into control valve from water inlet A, through valve core into injector inlet F, into the injector outlet E. This produces negative pressure so the brine is drawn into the valve. Water flow then goes into the riser pipe, through the bottom strainer into the tank, up through resin layer, valve core, and then flows out drain outlet C.

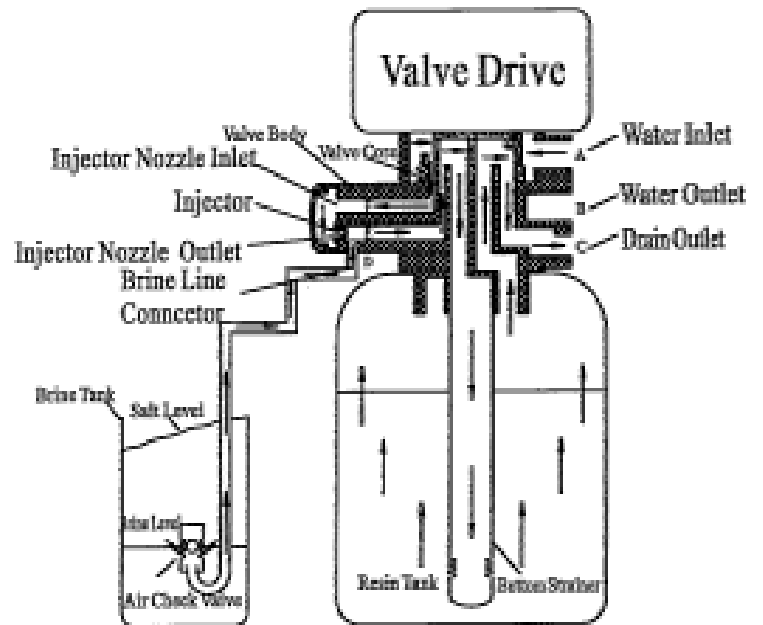

Slow Rinse Position

After absorbing all salt, raw water enters into control valve through water inlet A, through valve core into the injector nozzle, passes through the injector nozzle down to riser pipe, through bottom strainer, into the valve body, up through resin layer, into valve body, valve core, and flows out of drain outlet C.

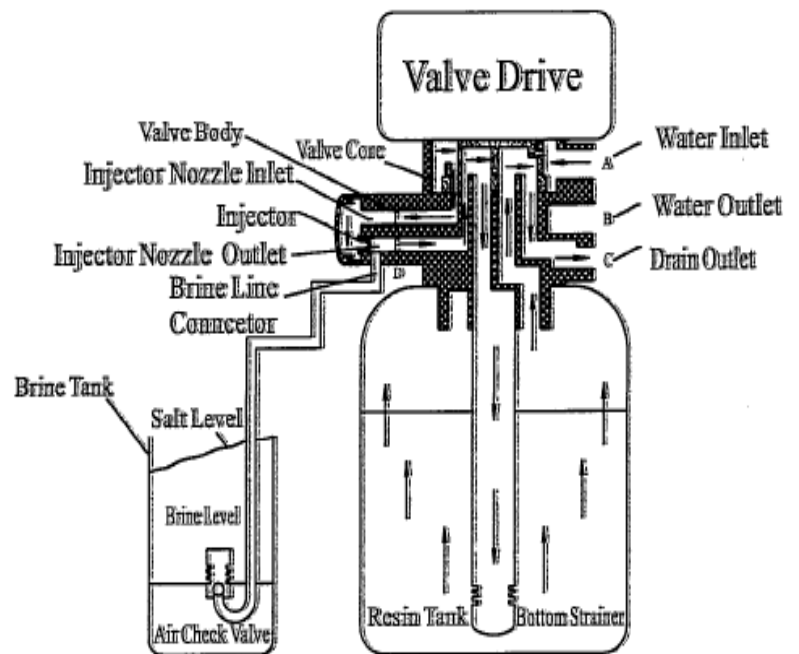

Secondary Backwash Position

Raw water enters into the control valve from water inlet A, through valve body from the top of valve core, then travels down through the riser tube and up through the resin, into the valve core, and finally flows out from drain outlet C.

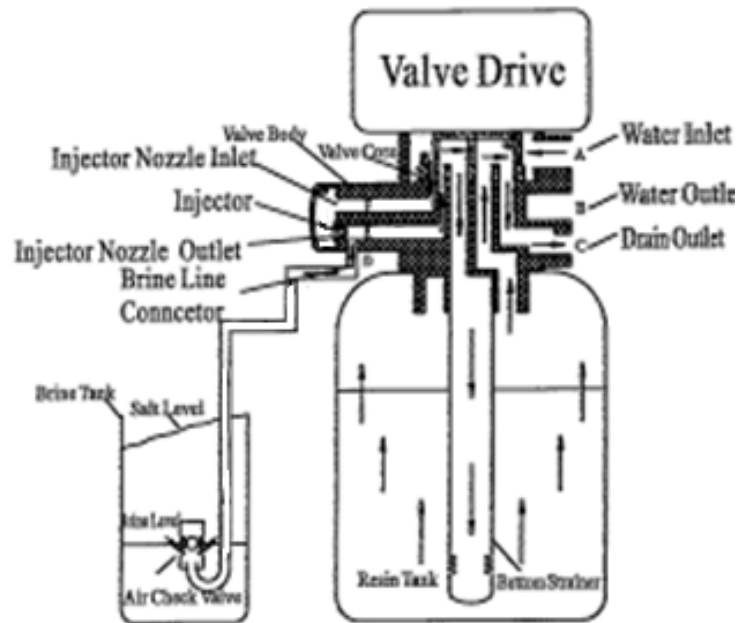

Brine Refill Position

Raw water enters into the valve from water inlet A, through the valve core to injector outlet E, into the brine line connector D and fills the brine tank; a small amount of water passes through injector outlet E to injector inlet F from the valve core, and flows out of drain outlet C.

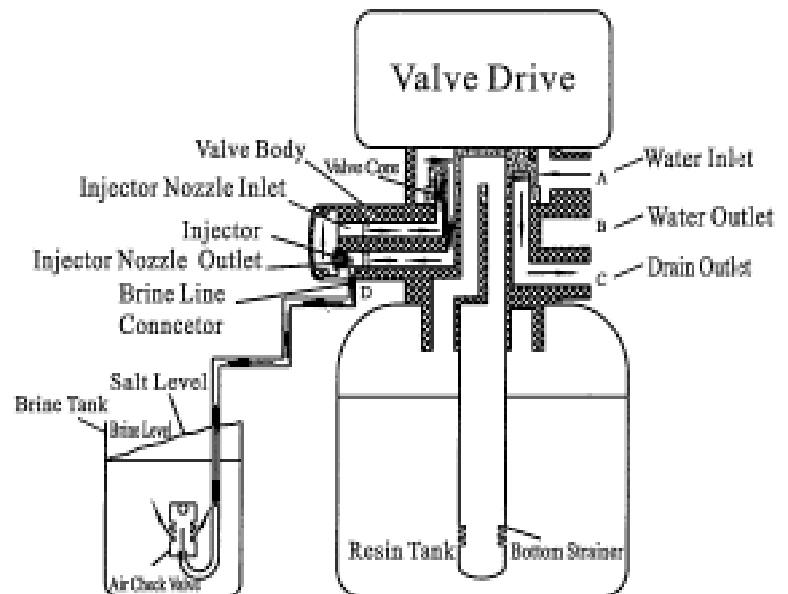

Fast Rinse Position

Raw water enters into the control valve from water inlet A, through the top of the valve core, into the tank from the top, down the riser pipe through bottom strainer and up through the resin layers, through valve core and flows out to drain outlet C.

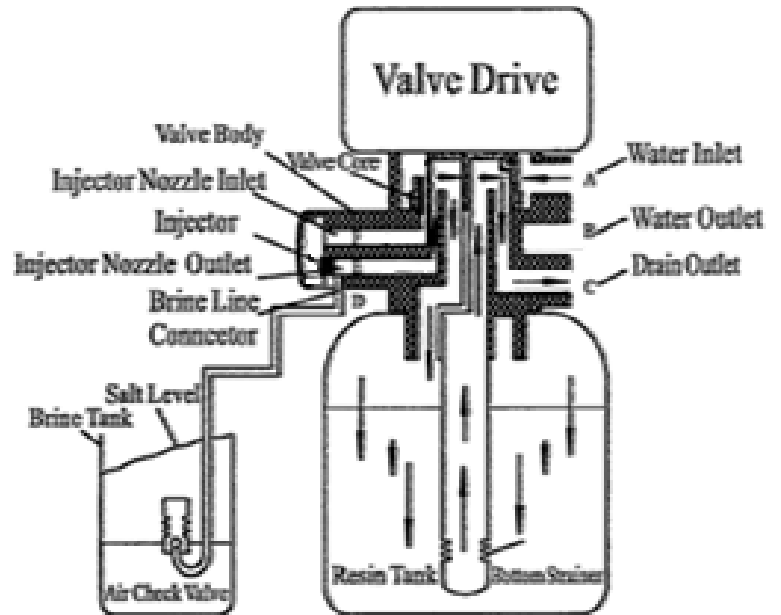

10. Assembly Drawings and Parts List

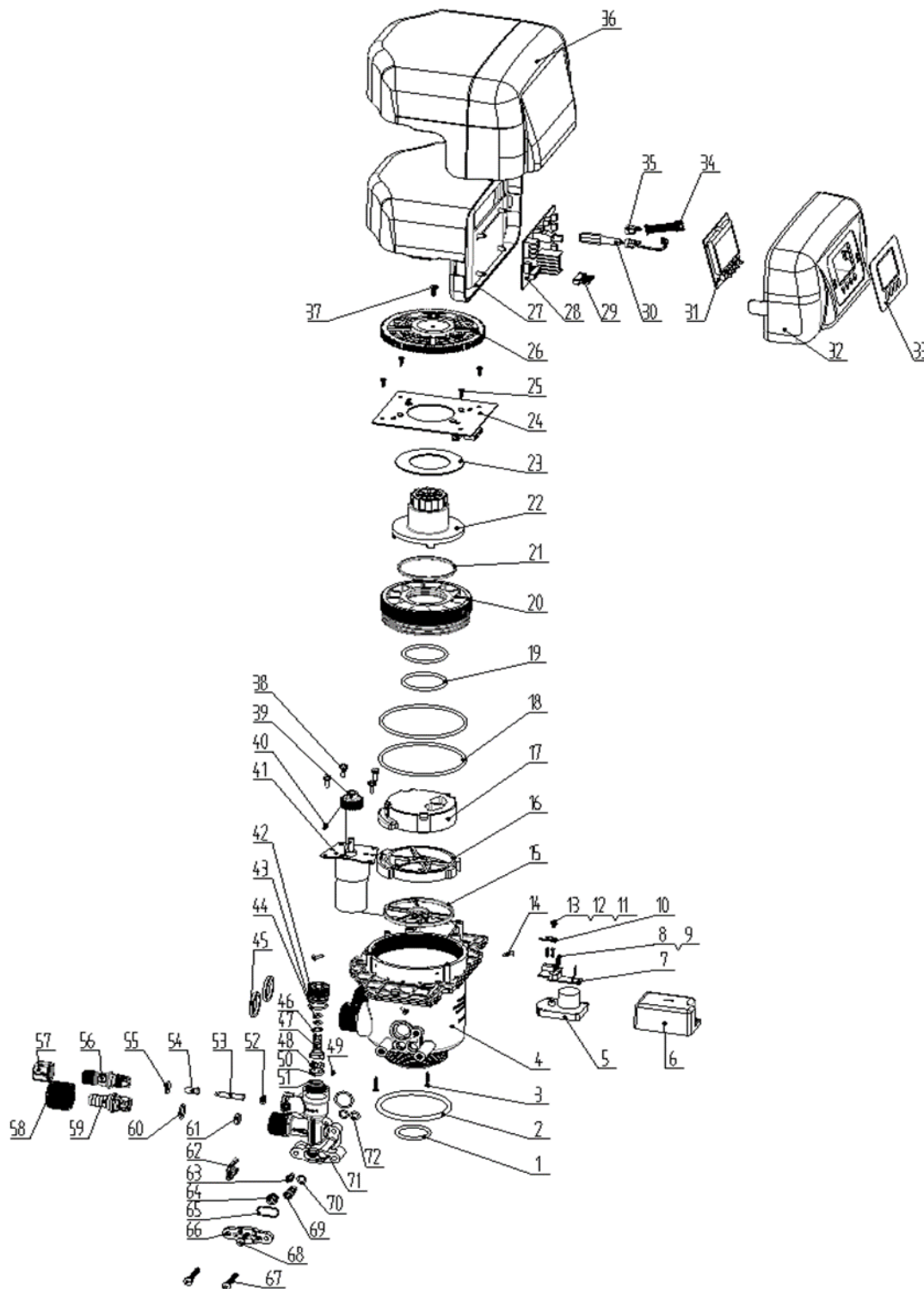



Item No.	Description	Part No.	Qty.
1	O-ring, 32.5X3.55	8378116	1
2	O-ring, 73x5.3	8378143	2
3	Screw, Cross ST2.9X16	8909010	1
4	Valve Body	8022742	1
5	Motor	6158052	1
6	Dust Cover	8005034	1
7	Control Board	6382025	1
8	Screw, Cross M2X10	8902035	1
9	Spring Washer 2	8953007	1
10	Pick	8152017	2
11	Washer	8952008	2
12	Spring Washer	8953008	1
13	Screw, Cross M3X6	8902034	3
14	Screw, Cross ST2.9X13	8909009	1
15	Seal Ring	8370075	1
16	Fixed Disk	8469048	2
17	Moving Disk	8459050	1
18	O-ring, 90x3.55	8378180	4
19	O-ring, 43.7x3.55	8378123	1
20	Fitting Nut	8092033	1
21	Moving Seal Ring	8370065	1
22	Shaft	8258014	4
23	Anti-friction Washer	8216012	1
24	Locating Board	6378007	1
25	Screw, Cross ST2.9X9.5	8909008	1
26	Gear	8241017	1
27	Dust Cover	8005033	1
28	Control Board	6382022	1
29	Wiring of Locating Board	5511014	2
30	Wire for power	8513001	1
31	Display Board	6381006	1
32	Front Cover	8300030	1
33	Label	8865040	1
34	Wire for Display Board	5512002	1
35	Cable Clip	8126004	1
36	Dust Cover	8300031	1

Item No.	Description	Part No.	Qty.
37	Screw, Cross ST3.9X13	8909013	2
38	Screw, Cross M4x12	8902005	1
39	Small Gear	8241019	1
40	Pin	8993003	1
41	Motor	6159511	1
42	Fitting Nut	8092034	1
43	O-ring, 17.5x2	8378182	1
44	O-ring, 6.08x1.78	8378155	4
45	Seal Ring 30OD X 24ID X 3.3	8371001	1
46	Anti-friction Washer	8216013	2
47	Valve Rod	8206012	1
48	Moving Disk	8459034	1
49	Screw, Cross ST2.2X6.5	8909004	1
50	Fixed Disk	8469050	1
51	Seal Ring	8370054	1
52	Brine Line Flow Control	8468052-8468057	4
53	Filter Screen	8336008	4
54	Tube	8457039	1
55	O-ring, 11x2	8378169	2
56	Connector	8458068	1
57	Hexagonal Nut	8940001	2
58	Articulated Nut	8945025	1
59	Connector	8458064	1
60	O-ring, 15x1.8	8378179	1
61	Drain Line Flow Control	8468042-4468045	1
62	Clip	8270004	1
63	Tube	8467001-8467010	1
64	Injector Nozzle	8454001-8454010	1
65	O-ring, 17x1.8	8378148	1
66	Injector Cover	8315003	1
67	Screw, Cross M5X35	8902017	1
68	Screw, Cross M5X23	8902015	1
69	Filter Screen	5336008	1
70	O-ring, 7x1.8	8378015	1
71	Injector Body	8008008	1
72	O-ring, 7.5x1.8	8378016	1

11. Troubleshooting

Control Valve

Problem	Cause	Correction
1. Softener fails to regenerate	<ul style="list-style-type: none"> A. Electrical service to unit has been interrupted. B. Regeneration cycles set incorrectly. C. Controller is defective. D. Motor failure. 	<ul style="list-style-type: none"> A. Check for consistent electrical service. B. Reset regeneration cycles. C. Replace controller. D. Replace motor.
2. Regeneration time is not correct	<ul style="list-style-type: none"> A. Time of Day not set correctly. B. Power failure over 3 days. 	Check program and reset time of day.
3. Hard water	<ul style="list-style-type: none"> A. Bypass valve is open or leaking. B. No salt in brine tank. C. Injector plugged. D. Insufficient water level in brine tank. E. Leak at O-ring on riser pipe. F. Internal valve leak. G. Regeneration cycles not correct. H. Shortage of resin. I. Bad quality of feed water or meter blocked. 	<ul style="list-style-type: none"> A. Close or repair bypass valve. B. Add salt to brine tank and maintain salt level above water level. C. Change or clean injector. D. Check brine tank refill time. E. Make sure riser pipe is not cracked. Check O-ring and tube pilot. F. Change valve body. G. Set correct regeneration cycles in the program. H. Add resin to mineral tank and check for leaks. I. Reduce the inlet turbidity, clean or replace meter.
4. Softener fails to draw brine	<ul style="list-style-type: none"> A. Line pressure is too low. B. Brine line is plugged. C. Brine line is leaking. D. Injector is plugged. E. Internal leakage. F. Drain line is plugged. G. Wrong size BLFC, DLFC and injector. 	<ul style="list-style-type: none"> A. Increase line pressure. B. Clean brine line. C. Replace brine line. D. Clean or replace injector. E. Replace valve body. F. Clean drain line flow control. G. Install properly sized BLFC, DLFC and injector. See Page 13.
5. Unit uses too much salt	<ul style="list-style-type: none"> A. Improper salt setting. (Brine refill time) B. Excessive water in brine tank. 	<ul style="list-style-type: none"> A. Check salt usage and salt setting. (Brine refill time) B. See problem no.6.
6. Excessive water in brine tank	<ul style="list-style-type: none"> A. Brine refill time is too long. B. Foreign material in brine line. C. Foreign material in brine valve or plugged drain line flow control. D. Power outage during brine fill. E. Safety valve in brine tank malfunction. 	<ul style="list-style-type: none"> A. Reset correct refilling time. B. Clean brine line. C. Clean brine valve, and DLFC. D. Put the valve in bypass. Install a safety float in brine tank. E. Repair or replace brine safety valve.

7. Pressure lost or iron in conditioned water	<ul style="list-style-type: none"> A. Iron in the water supply pipes. B. Iron mass in the softener. C. Fouled resin bed. D. Too much iron in the raw water. 	<ul style="list-style-type: none"> A. Clean the water supply pipe. B. Clean valve and add resin cleaning chemical, increase frequency of regeneration. C. Check backwash, brine draw and brine refill. Increase frequency of regeneration and backwash time. D. Install Iron removal equipment before softening.
8. Loss of mineral through drain line	<ul style="list-style-type: none"> A. Air in water system. B. Bottom strainer broken. C. Improperly sized drain line control (DLFC). 	<ul style="list-style-type: none"> A. Assure that well system has proper air eliminator control. B. Replace bottom strainer. C. Check for proper drain rate.
9. Control cycles continuously	<ul style="list-style-type: none"> A. Signal to the locating PCB is interrupted. B. Controller is faulty. C. Foreign material in the drive gear. D. Time of regeneration steps were set to zero. 	<ul style="list-style-type: none"> A. Check the connection between the main PCB to the locating PCB. B. Replace controller. C. Remove blockage in drive gear. D. Check program setting and reset.
10. Drain flows continuously	<ul style="list-style-type: none"> A. Internal valve leak. B. Interrupted power supply during backwash. 	<ul style="list-style-type: none"> A. Check and repair valve body or replace it. B. Adjust valve to service position or turn off bypass valve and restart when power is restored.
11. Interrupted or irregular brine	<ul style="list-style-type: none"> A. Water pressure too low or not stable. B. Injector is plugged or faulty. C. Air in resin tank. 	<ul style="list-style-type: none"> A. Increase water pressure. B. Clean or replace injector. C. Check and find the reason.
12. Water flows from drain or brine line after regeneration	<ul style="list-style-type: none"> A. Foreign material in the valve body. B. Hard water mixed in valve body. C. Water pressure is too high. 	<ul style="list-style-type: none"> A. Clean foreign material in valve body. B. Change valve core or sealing ring. C. Reduce water pressure or use pressure release function.
13. High concentration of brine	<ul style="list-style-type: none"> A. Foreign material in injector. B. Brine valve cannot be shut-off. C. Rapid rinse time is too short. 	<ul style="list-style-type: none"> A. Clean and repair injector. B. Replace brine valve or clean it. C. Extend rapid rinse time.
14. Decreased Capacity	<ul style="list-style-type: none"> A. Regeneration is not occurring. B. Fouled resin bed. C. Safety float is not at the proper height or brine time is low. D. Softener setting not proper. E. Raw water quality has altered. F. Flow meter is slow or stationary. 	<ul style="list-style-type: none"> A. Reset regeneration parameters. B. Increase backwash flow rate and time, clean or change resin. C. Adjust brine draw time and float height. D. Re-test the water and change the valve parameters. E. Regenerate unit manually then reset regeneration cycle. F. Disassemble and clean flow meter or replace.
15. Power Outage Occurs During Regeneration	<ul style="list-style-type: none"> A. System locked in current phase/cycle. 	<ul style="list-style-type: none"> A. Close the bypass until power resumes. If power outage lasts over 72 hours, the time of day will need to be reset.

Electronics

Problem	Cause	Correction
1. Abnormal display	<ul style="list-style-type: none"> A. Wiring to the front panel is loose. B. Control board is faulty. C. Transformer malfunction. D. Electrical service unstable. 	<ul style="list-style-type: none"> A. Check and replace the wiring. B. Replace control board. C. Check and replace transformer. D. Verify power source.
2. Blank display	<ul style="list-style-type: none"> A. Wiring to the front panel is loose. B. Front panel damaged. C. Control board damaged. D. Electricity is interrupted. 	<ul style="list-style-type: none"> A. Check and replace wiring. B. Replace front panel. C. Replace control board. D. Check power source.
3. E1 code	<ul style="list-style-type: none"> A. Wiring of locating board with controller fails to work. B. Locating board damaged. C. Mechanical drive failure. D. Faulty control board. E. Wiring to the motor has a short. F. Motor damaged. 	<ul style="list-style-type: none"> A. Replace wiring. B. Replace locating board. C. Replace Discs or drive gear. D. Replace control board. E. Replace wiring. F. Replace motor.
4. E2 code	<ul style="list-style-type: none"> A. Hall effect on locating board damaged. B. Possible short in the wiring to the locating board. C. Control board malfunction. 	<ul style="list-style-type: none"> A. Replace locating board. B. Replace wiring. C. Replace control board.
5. E3 or E4 code	<ul style="list-style-type: none"> A. Control board malfunction. 	<ul style="list-style-type: none"> A. Replace control board.



12. Replacement Parts

Description	Part Number	Quantity
Brine Assembly Kit, 3/8" - #63, #64, #65, #66, #68, #73	REVV-217	
Brine Screen and Tube - #63, #65	REVV-218	1
Bypass Clip	8270004	1
Control Board Kit - #35, #37, #39	REVV-221	1 Kit
Display Board Kit - #33, #34, #37	REVV-222	1 Kit
DLFC Buttons, BLFC Buttons & Injector Kit	REVV-215	1 Kit
Drain Assembly Kit - #67, #69, #71	REVV-216	1 Kit
Injector Body Assembly Kit - #1-3, #5, #7-11, #13, #56-69, #71, #73	REVV-220	1 Kit
Injector Cover O-ring - #3	8378148	1
Injector Filter Screen Kit - #5, #7	REVV-219	1 Kit
Locating Board Kit - #44, #45, #38	REVV-223	1 Kit
Meter Cable Assembly Kit - #36 & #37	REVV-232	1 Kit
Motor - #20	6158012	1
Motor, Brine - #17	6159052	1
O-ring, Valve Body - #12	8378143	1
O-ring, Valve Center Hub - #14	8378116	1
Transformer, 12VDC	6379021	1
Upper Distributor Basket, 32mm	REVV-213	1

13. Accessories

Description	Part Number	Figure	Quantity
Dust Cover	72605-CV		1
Animated Connector with Flow Meter	AC/FM-F82		1 Pair
1" Inlet/Outlet Female to Female Adaptor	REVV-208		1
¾" 90 ° Inlet/Outlet Elbow	REVV-209		1
1" 90 ° Inlet/Outlet Elbow	REVV-210		1
¾" Male Adaptor	REVV-211		1
¾" Electronic 2-Way Ball Valve	F93-B		1
1" Electronic 2-Way Ball Valve	F93-C		1
1.5" Electronic 2-Way Ball Valve	F93-D		1
2" Electronic 2-Way Ball Valve	F93-E		1
1" Ceramic Tee 3-Way Ball Valve	F94-C		1

14. Packing List

Valve Packing List

Description	Part Number	Figure	Qty.
Control Valve	72605-HK 72605B-HK		1
12VDC Transformer	6379021		1
User Manual			1
Parts			
Valve Base O-ring	8378143		1
Interlock Cable	5515002		1
Washers	8371001		2
Filter Screen & Bushing	REVV-218		1 Set
Injector Cover O-ring	8378148		2
3/8" Brine Nut	8940001		1
Injector and Button Kit – REVV-215			
Injector Nozzle & Throat	6301, 6302, 6303, 6304, 6305, 6306, 6307, 6308, 6309, 6310		1 Set
Drain Line Flow Controls	8468042, 8468043, 8468044, 8468045, 8468060, 8468061, 8468062, 8468063		1 Set
Brine Line Flow Controls	8468052, 8468053, 8468054, 8468055, 8468056, 8468057		1 Set

System Packing List

Description	Part Number	Qty.
RevV4 Control Valve	72605-HK, 72605B-HK	1
Pressure Tank and Media (media may be installed in tank or bulk separate)	Varies	1
Distributor Tube and Lower Basket (installed in pressure tank)	REVV-PTT10-66	1
Upper Basket	REVV-213	1
Brine Tank and Float Assembly	Varies	1
3/8" Brine Line	BL3/8	4'
Grease Packet	SG-3005	1
Customer Manual	---	1
Tank Label (elements systems only)	PTL-01	1
Warranty Card	---	1

15. Hankscraft Runxin, LLC Warranty Statement

LIMITED WARRANTY

As described herein, Hankscraft Runxin, LLC ("Hankscraft Runxin"), warrants its products are free from defects in material and workmanship only, when properly installed, operated, and maintained. This warranty is subject to the exceptions herein.

Hankscraft Runxin warrants to the original owner that the items listed below, excluding but not limited to wear parts like O-rings, gaskets and seals, will be free from defects in materials and workmanship for the period of time specified below from the original purchase date.

Product or Component	Warranty Period
Ceramic Internals	Lifetime
Pressure Tanks	Ten (10) Years
Brine Tanks	Five (5) Years
Control & Ball Valves	Five (5) Years
Backwash Pre-filters	Five (5) Years
All Other Components	One (1) Year

Media/resin is not warranted due to water supply quality differences.



Any parts used for replacement are warranted for the remainder of the original warranty period applicable to the part from the date of manufacture so long as the parts are installed by a Hankschaft Runxin factory trained and authorized installer.

Hankschaft Runxin's obligation by this Limited Warranty, at its option, is to repair or replace any warranted product only. Labor for repair or replacement is not included as part of this warranty. Prior to returning the product to Hankschaft Runxin, a valid return materials authorization number must be obtained from Hankschaft Runxin. Any product returned to Hankschaft Runxin without a valid return authorization number will be rejected. Any product found to be defective will, at the sole discretion of Hankschaft Runxin, be repaired or replaced. Hankschaft Runxin is not responsible for shipping cost to the repair facility. This section lists the sole remedies for any valid warranty claim.

This warranty does not apply to defects reported to Hankschaft Runxin outside of the warranty period.

This warranty does not apply to defects caused by installing, operating, servicing, modifying, repairing or maintaining (or lack of maintaining) the product outside of Hankschaft Runxin's recommendations. Filters, membrane elements and flow restrictors that become fouled or plugged due to excessive turbidity, dissolved solids, or microorganisms are not covered by this warranty. This warranty does not apply to defects caused by damage during shipment, neglect, misuse, modification, accident, noncompliance with local codes and ordinances, hot water, frozen water, sediment, corrosive liquids, gases, chemicals, bacteria, animals, sand, salt, flood, wind, fire, outdoor installations where the product is not reasonably covered, pneumatic use, natural disasters, war, terrorism or acts of God. No other person is authorized to make any other warranty on behalf of Hankschaft Runxin either during or after the applicable warranty period.

Hankschaft Runxin assumes no liability for determining the proper products and equipment or installation necessary to meet the requirements of the user of the product, and Hankschaft Runxin does not authorize others to assume such liability on its behalf.

THE WARRANTIES AND REMEDIES HEREIN ARE EXCLUSIVE AND IN LIEU OF ANY AND ALL OTHER WARRANTIES OR REMEDIES EITHER EXPRESSED OR IMPLIED, HEREIN OR ELSEWHERE, INCLUDING WITHOUT LIMITATION WARRANTIES OF MERCHANTABILITY, FITNESS FOR ANY PARTICULAR PURPOSE, NON-INFRINGEMENT OR WARRANTIES RESULTING FROM COURSE OF PERFORMANCE, COURSE OF DEALING OR FROM USAGE OF TRADE. HANKSCRAFT RUNXIN HEREBY DISCLAIMS ALL OTHER WARRANTIES. HANKSCRAFT RUNXIN'S LIABILITY SHALL NOT EXCEED THE COST OF THE PRODUCT. HANKSCRAFT RUNXIN IS NOT RESPONSIBLE FOR INCIDENTAL OR CONSEQUENTIAL DAMAGES OR EXPENSES OF ANY KIND WHATSOEVER, INCLUDING LOSS OF PROFITS, UNDER ANY CIRCUMSTANCES AND REGARDLESS OF WHETHER HANKSCRAFT RUNXIN WAS AWARE OF THE POSSIBILITY OF ANY SUCH LOSS.

16. System Configuration and Settings

Installer

Name: _____

Address: _____ City/State: _____

Phone: _____ Install Date: _____

Softener System Configuration

Tank Size: Dia. _____ In Height _____ in Resin Volume: _____ cu/ft.

Brine Tank Capacity: 85L 100L 130L

Media: _____

Control Valve Model: _____ Serial Number: _____

DLFC Size: _____ BLFC Size: _____ Injector: _____

Valve Programming

Regen Cycles: Cycle 1 Cycle 2 Cycle 3

Mode: A-01 Meter Delay A-02 Meter Immediate A-03 Intelligent Meter Delay

A-04 Intelligent Meter Immediate A-05 Remaining Compare A-06 Timer A-07 Filter

Water Conditions and Quality

Total Hardness: _____ grains Iron (Fe): _____ ppm Acid (pH): _____

TDS: _____ ppm Pressure of Inlet Water: _____ PSI

Other: _____

Water Source: Well Water City Water Other: _____



17. Factory Default Settings

Parameter	Unit	Factory Default	Programmed Settings
Language		English	
Program Type		Interlock	
Regeneration Sequence		2	
Water Treatment Capacity (A-01,02,03,04,05,07)	Gallons	2100	
Number of People in Household (A-03)		4	
Regeneration Mode (A-01,02,03,04,05,06,07)		A-03	
Regeneration Time	24-hr. clock	02:00	
Backwash Time	Min.	0	
Brine & Slow Rinse Time	Min.	60	
Secondary Backwash Time	Min.	10	
Fast Rinse Time	Min.	10	
Brine Refill Time	Min:Sec	10:00	
Service Alarm	D	730	
Max Regeneration Days	D	30	
Signal Output Mode b-01 (02)		b-01	



Made in USA